



Grid-connected PV Inverter

SUN-3K-G05-1-P

SUN-3K-G05-P

SUN-4K-G05-P

SUN-5K-G05-P

SUN-6K-G05-P

SUN-7K-G05-P

SUN-8K-G05-P

SUN-9K-G05-P

SUN-10K-G05-P

SUN-12K-G05-P

User Manual



Contents

| | |
|--|--------|
| 1. Introduction | - 2 - |
| 1.1 Appearance Introduction | - 2 - |
| 1.2 Parts list | - 3 - |
| 2. Safety warnings and instructions | - 4 - |
| 2.1 Safety signs | - 4 - |
| 2.2 Safety instructions | - 4 - |
| 2.3 Notes for using | - 5 - |
| 3. Operation Interface | - 6 - |
| 3.1 Interface View | - 6 - |
| 3.2 Status Indicator | - 6 - |
| 3.3 Buttons | - 7 - |
| 3.4 LCD Display | - 7 - |
| 4. Product installation | - 8 - |
| 4.1 Select installation location | - 8 - |
| 4.2 Inverter Installation | - 10 - |
| 5. Electrical Connection | - 12 - |
| 5.1 PV Module Selection | - 12 - |
| 5.2 DC input terminal connection | - 12 - |
| 5.3 AC input terminal connection | - 14 - |
| 5.4 The connection of the ground line | - 17 - |
| 5.5 Max. over current protection device | - 18 - |
| 5.6 Inverter monitoring connection | - 18 - |
| 5.7 Installation of datalogger | - 19 - |
| 5.8 Configuration of datalogger | - 19 - |
| 6. Startup and Shutdown | - 19 - |
| 6.1 Start up the inverter | - 20 - |
| 6.2 Inverter Shutdown | - 20 - |
| 6.3 Anti-PID Function(optional) | - 20 - |

- 7. Zero-export function via energy meter** - 21 -
 - 7.1 Use of zero-export function - 30 -
 - 7.2 Sensor Clamp(optional) - 40 -
 - 7.3 Use of limiter function - 40 -
 - 7.4 How to browse the load power of your PV grid-tieplant on monitoring platform? - 41 -
- 8. General Operation** - 43 -
 - 8.1 The initial interface - 46 -
 - 8.2 Submenus in the Main Menu - 47 -
 - 8.3 System param setting - 49 -
 - 8.4 Running param setting - 50 -
 - 8.5 Protect Param setting - 66 -
 - 8.6 Comm. param setting - 68 -
- 9. Repair and Maintenance** - 69 -
- 10. Error information and processing** - 69 -
 - 10.1 Error code - 70 -
- 11. Specification** - 74 -

About This Manual

The manual mainly describes the product information, guidelines for installation, operation and maintenance. The manual cannot include complete information about the photovoltaic (PV) system.

How to Use This Manual

Read the manual and other related documents before performing any operation on the inverter. Documents must be stored carefully and be available at all times. **Contents may be periodically updated or revised due to product development. The information in this manual is subject to change without notice.** The latest manual can be acquired via service@deye.com.cn

Photovoltaic Grid-connected System

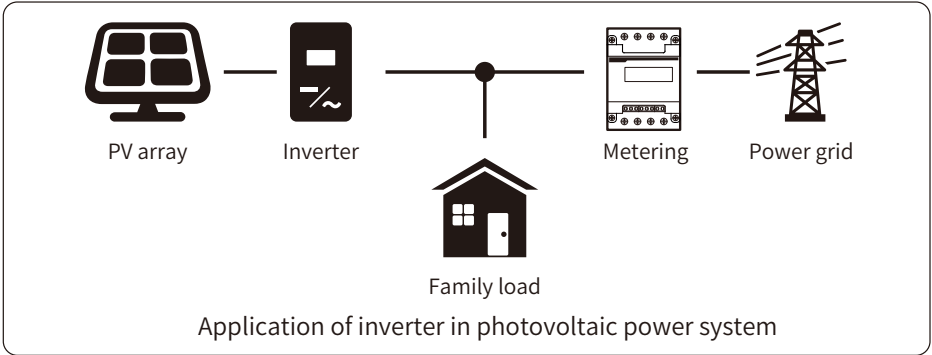

1. Introduction

1.1 Appearance Introduction

On-grid Inverter can convert solar panel DC power into AC power which can directly input to the grid. Its appearance is shown below. These models contain SUN-3K-G05-1-P, SUN-3K-G05-P, SUN-4K-G05-P, SUN-5K-G05-P, SUN-6K-G05-P, SUN-7K-G05-P, SUN-8K-G05-P, SUN-9K-G05-P, SUN-10K-G05-P, SUN-12K-G05-P.

The following is collectively referred to as “inverter” .

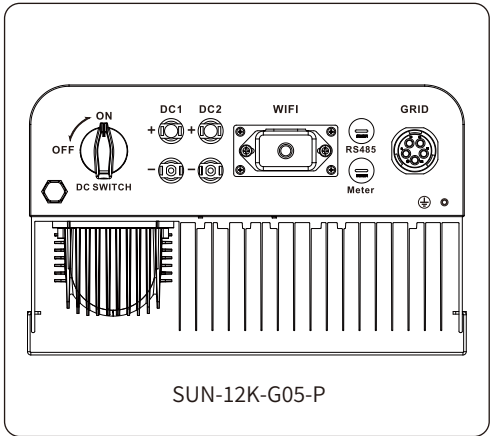
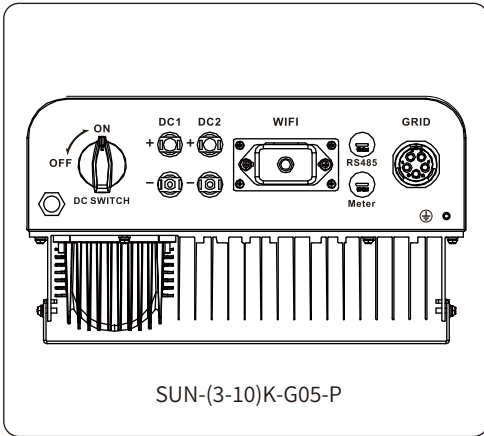
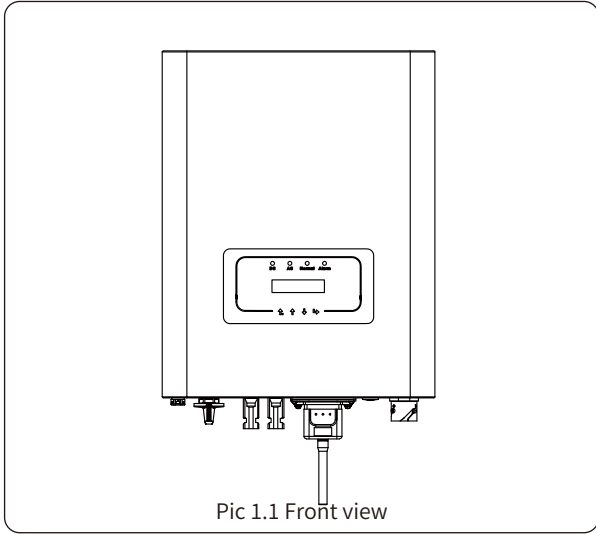

Pic 1.2 Bottom view

1.2 Parts list

Please check the following table, to see whether all the parts are included in the package:

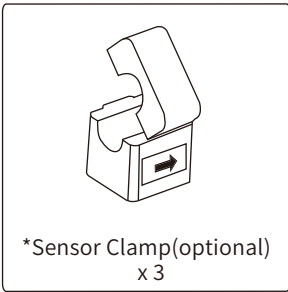
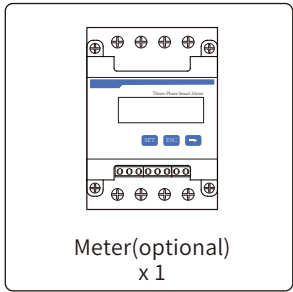
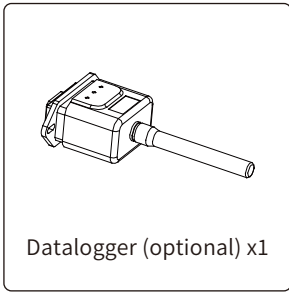
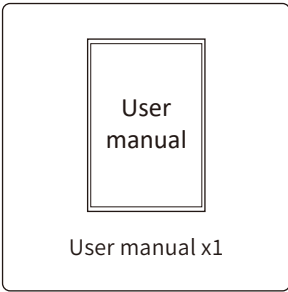
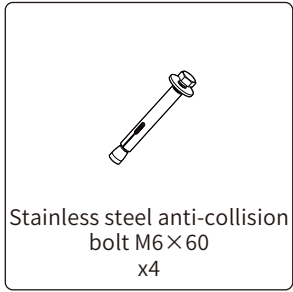
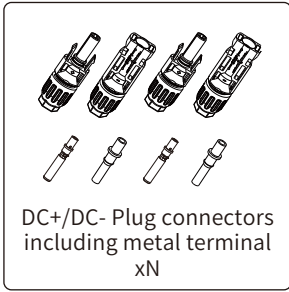
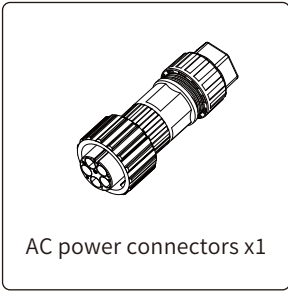
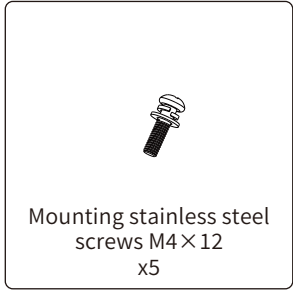
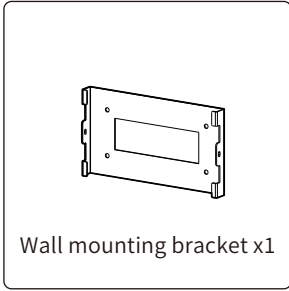
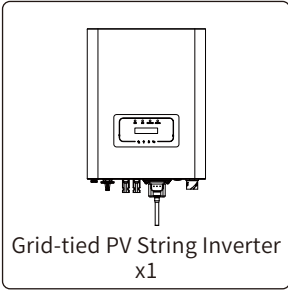

2. Safety warnings and instructions

Improper use may result in potential electric shock hazards or burns. This manual contains important instructions that should be followed during installation and maintenance. Please read these instructions carefully before use and keep them for future reference.

2.1 Safety signs

Safety symbols used in this manual, which highlight potential safety risks and important safety information, are listed as follows:



Warning:

Warning symbol indicates important safety instructions, which if not correctly followed, could result in serious injury or death.



Shock Hazard:

Caution, risk of electric shock symbol indicates important safety instructions, which if not correctly followed, could result in electric shock.



Safety Hint:

Note symbol indicates important safety instructions, which if not correctly followed, could result in some damage or the destruction of the inverter.



High Temperature Hazard:

Caution, hot surface symbol indicates safety instructions, which if not correctly followed, could result in burns.

2.2 Safety instructions



Warning:

Electrical installation of the inverter must conform to the safety operation rules of the country or local area.



Warning:

Inverter adopts non-isolated topology structure, hence must insure DC input and AC output are electrical isolated before operating the inverter.



Shock Hazard:

Prohibit disassembling inverter case, there existing shock hazard, which may cause serious injury or death, please ask qualified person to repair.

**Shock Hazard:**

When PV module is exposed to sunlight, the output will generate DC voltage. Prohibit touching to avoid shock hazard.

**Shock Hazard:**

While disconnect the input and output of the inverter for maintenance, please waits for at least 5 mins until the inverter discharge the remnant electricity.

**High Temperature Hazard:**

Local temperature of inverter may exceed 80°C while under operating. Please do not touch the inverter case.

2.3 Notes for using

The single phase string power inverter is designed and tested under related safety regulations. It can ensure the personal safety of the user. But as a electric device, it may cause shock or injury by incorrect operation. Please operate the unit under below requirements:

1. Inverter should be installed and maintained by qualified person under local standard regulations.
2. Must disconnect the AC side first, then disconnect DC side while doing installation and maintenance, after that, please wait at least 5 mins to avoid getting shocked.
3. Local temperature of the inverter may exceed 80 °C while under operating. Do not touch to avoid getting injured.
4. All electrical installation must be in accord with local electrical standards, and after obtaining the permission of the local power supply department, the professionals can connect the inverter to the grid.
5. Please take appropriate anti-static measure.
6. Please install where children can not touch.
7. The steps to start the inverter: 1) switch on the AC side circuit breaker, 2) Switch on the DC side circuit breaker of the PV panel. 3) Turn on the DC switch of the inverter.

The steps to stop the inverter: 1) switch off the AC side circuit breaker, 2) switch off the DC side circuit breaker of the PV panel. 3) Turn off the DC switch of the inverter.

8. Don't insert or remove AC and DC terminals when the inverter is in normal operation.
9. The DC input voltage of the inverter must not exceed the maximum value of the model.

3. Operation Interface

3.1 Interface View

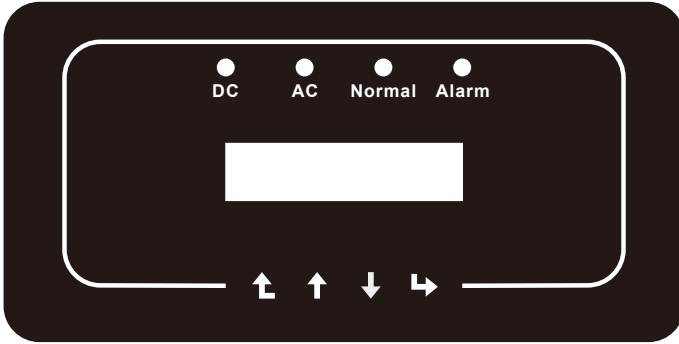

Pic 3.1 Front panel display

3.2 Status Indicator

There are four LED status indicator lights in the front panel of the inverter. Please see table 3.1 for details.

| Indicator | status | Explanation |
|-----------|--------|----------------------------------|
| ● DC | on | Inverter detects DC input |
| | off | Low DC input voltage |
| ● AC | on | Grid Connected |
| | off | Grid Unavailable |
| ● NORMAL | on | Under normal operating |
| | off | Stop operating |
| ● ALARM | on | Detected faults or report faults |
| | off | Under normal operating |

Table 3.1 Status indicator lights

3.3 Buttons

There are four keys in the front panel of the Inverter(from left to right): Esc, Up, Down and Enter keys. The keypad is used for:

- Scrolling through the displayed options (the Up and Down keys);
- Access to modify the adjustable settings (the Esc and Enter keys).



3.4 LCD Display

The two-line Liquid Crystal Display (LCD) is located on the front panel of the Inverter, which shows the following information:

- Inverter operation status and data;
- Service messages for operator;
- Alarm messages and fault indications.

4. Product installation

4.1 Select installation location

To select a location for the inverter, the following criteria should be considered:

WARNING: Risk of fire

- Do not install the inverter in areas containing highly flammable materials or gases.
- Do not install the inverter in potentially explosive atmospheres.
- Do not install in small closed spaces where air can not circulate freely. To avoid overheating, always make sure the flow of air around the inverter is not blocked.
- Exposure to direct sunlight will increase the operational temperature of the inverter and may cause output power limiting. It is recommended that inverter installed to avoid direct sunlight or raining.
- To avoid overheating ambient air temperature must be considered when choosing the inverter installation location. It is recommended that using a sun shade minimizing direct sunlight when the ambient air temperature around the unit exceeds 104°F/40°C.

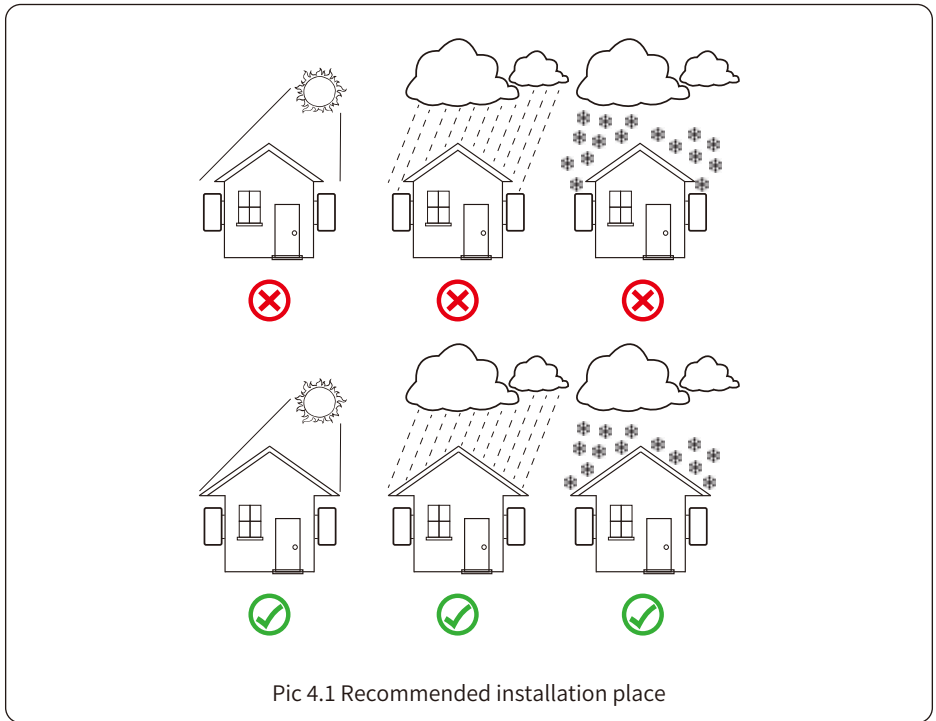

Pic 4.1 Recommended installation place

- Install on a wall or strong structure capable of bearing the weight.
- Install vertically with a maximum incline of $\pm 15^\circ$. If the mounted inverter is tilted to an angle greater than the maximum noted, heat dissipation can be inhibited, and may result in less than expected output power.
- If install more than one inverter, must leave at least 500mm gap between each inverter. And two adjacent inverters are also separated by at least 500 mm. And must install the inverter at the place where children cannot touch. Please see picture 4.3.
- Consider whether the installation environment is helpful to see the inverter LCD display and indicator status clearly.
- Must offer a ventilate environment if inverter installed in the airtight house.



Safety Hint:

Do not place or store any items next to the inverter.

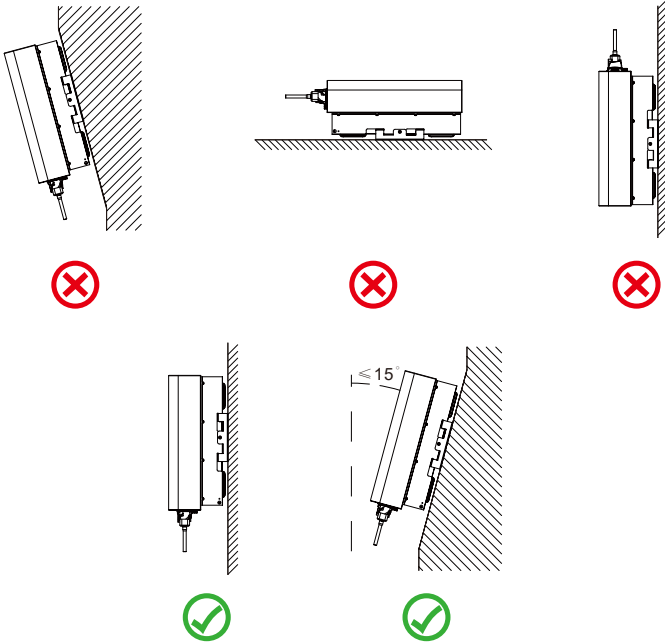

Pic 4.2 Installation Angle

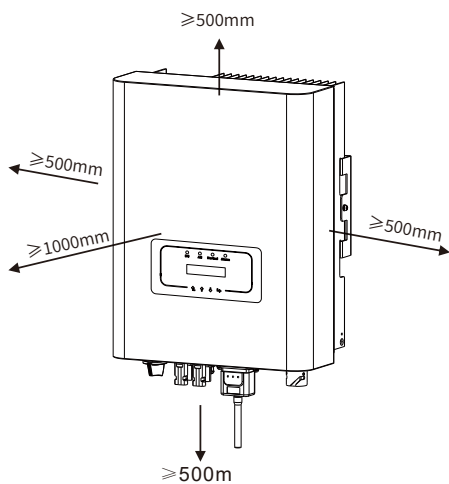

Pic 4.3 Installation Gap

4.2 Inverter Installation

The inverter is designed according to the wall mounted type installation, please use the wall mounted (the brick wall of the expansion bolt) when installing.

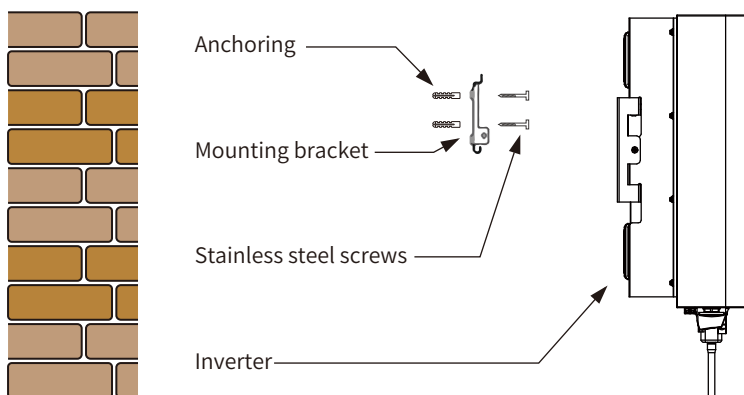

Pic 4.4 Inverter Installation

Procedure shows below:

1. Locate on the appropriate wall according to the bolt position on the mounting bracket, then mark the hole. On the brick wall, the installation must be suitable for the expansion bolt installation.

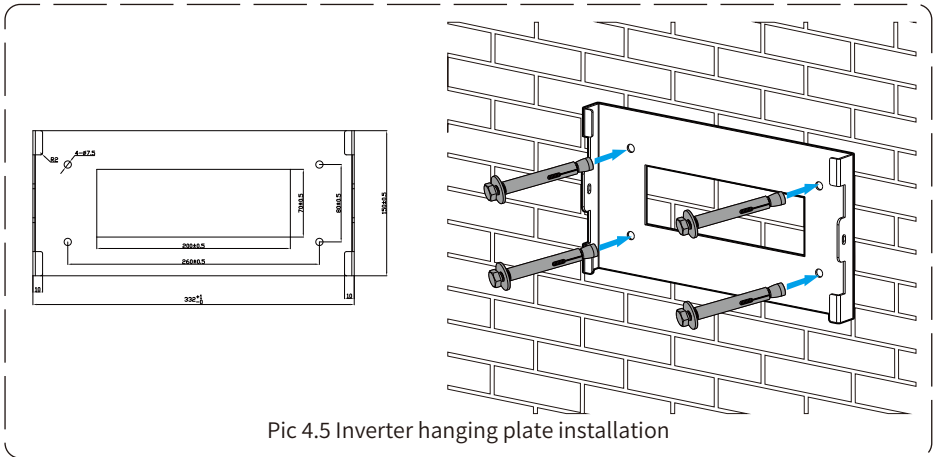

2. Ensure that the position of the installation holes on the wall is in accordance with the mounting plate, and the mounting rack is vertically placed.
3. Hang the inverter to the top of the mounting rack and then use the M4 screw in the accessory to lock inverter heat sink to the hanging plate, to ensure that the inverter will not move.

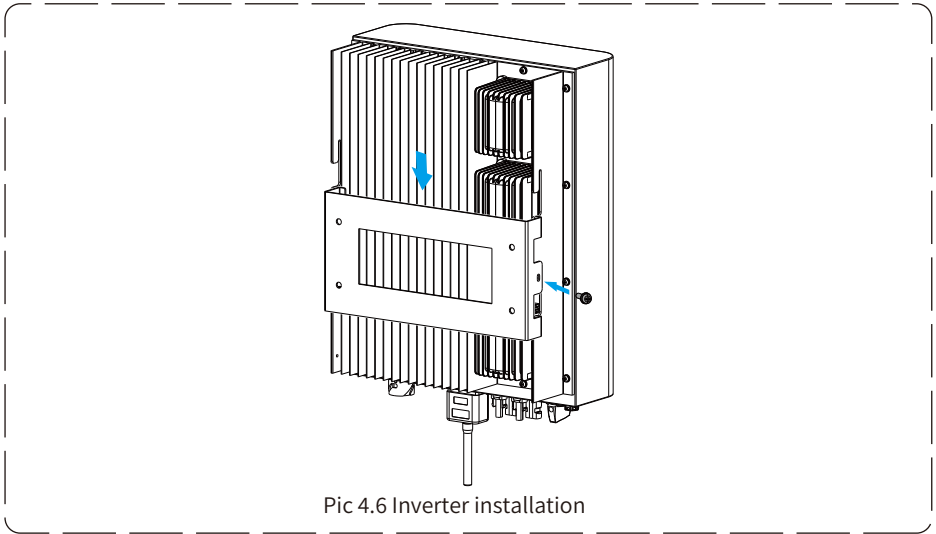

5 Electrical Connection

5.1 PV Module Selection:

When selecting proper PV modules, please be sure to consider below parameters:

- 1) Open circuit Voltage (Voc) of PV modules not exceeds max. PV array open circuit voltage of inverter.
- 2) Open circuit Voltage (Voc) of PV modules should be higher than min. start voltage.
- 3) The PV modules used to connected to this inverter shall be Class A rating certified according to IEC 61730.

| Inverter Model | 3KW-1 | 3KW | 4KW | 5KW | 6KW | 7KW | 8KW | 9KW | 10KW | 12KW |
|--------------------------------|-------------------|-----|-----|-----|-----|-----|-----|-----|------|-----------|
| PV Input Voltage | 600V (120V~1000V) | | | | | | | | | |
| PV Array MPPT Voltage Range | 120V~850V | | | | | | | | | 200V~850V |
| No. of MPP Trackers | 1 | 2 | | | | | | | | |
| No. of Strings per MPP Tracker | 1 | 1 | | | | | | | | |

5.2 DC input terminal connection

1. Switch the Grid Supply Main Switch(AC)OFF.
2. Switch the DC Isolator OFF.
3. Assemble PV input connector to the inverter.



Warning:

When using PV modules, please ensure the PV+ & PV- of solar panel is not connected to the system ground bar.



Safety Hint:

Before connection, please make sure the polarity of the output voltage of PV array matches the “DC+” and “DC-” symbols.



Warning:

Before connecting inverter, please make sure the PV array open circuit voltage is within the 1000V of the inverter.



Pic 5.1 DC+ male connector

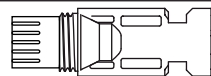

Pic 5.2 DC- female connector



Safety Hint:

Please use approved DC cable for PV system.

| Cable type | Cross section (mm ²) | |
|---|----------------------------------|-------------------|
| | Range | Recommended value |
| Industry generic PV cable (model: PV1-F) | 4.0~6.0 (12~10AWG) | 4.0(12AWG) |

Table 5.1 DC Cable Specifications

The steps to assemble the DC connectors are listed as follows:

- a) Strip off the DC wire about 7mm, disassemble the connector cap nut (see picture 5.3).

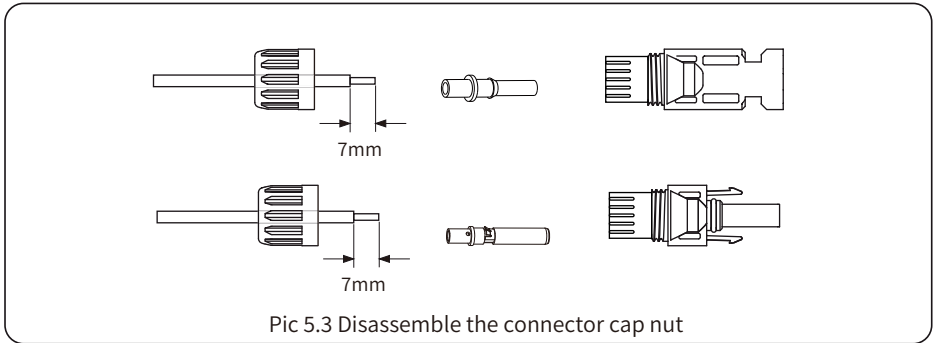

Pic 5.3 Disassemble the connector cap nut

- b) Crimping metal terminals with crimping pliers as shown in picture 5.4.

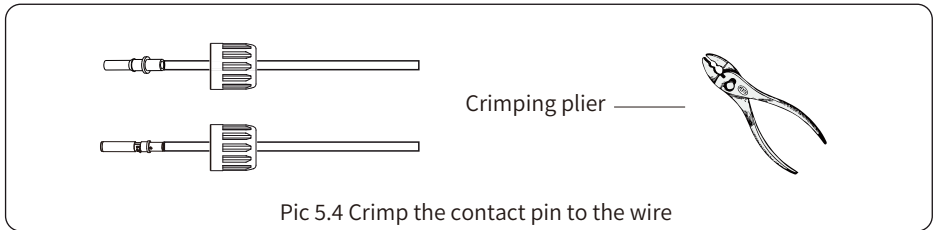

Pic 5.4 Crimp the contact pin to the wire

- c) Insert the contact pin to the top part of the connector and screw up the cap nut to the top part of the connector. (as shown in picture 5.5).

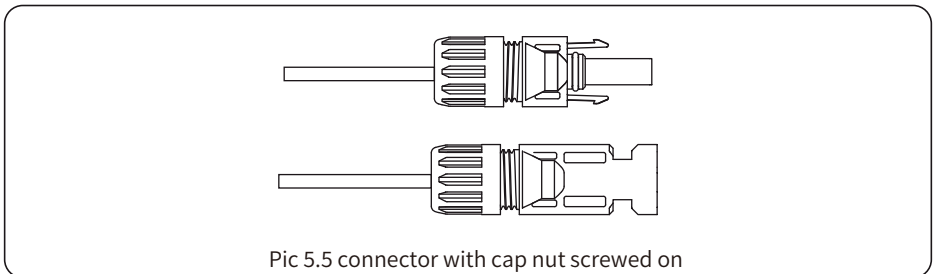

Pic 5.5 connector with cap nut screwed on

d) Finally insert the DC connector into the positive and negative input of the inverter ,shown as picture 5.6.

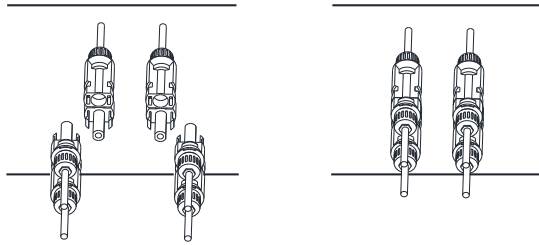

Pic 5.6 DC input connection



Warning:

Sunlight shines on the panel will generate voltage, high voltage in series may cause danger to life. Therefore, before connecting the DC input line, the solar panel needs to be blocked by the opaque material and the DC switch should be 'OFF', otherwise, the high voltage of the inverter may lead to life-threatening conditions.



Warning:

Please use its own DC power connector from the inverter accessories. Do not interconnect the connectors of different manufacturers. Max. DC input current should be 20A. if exceeds, it may damage the inverter and it is not covered by Deye warranty.

5.3 AC input terminal connection

Do not close the DC switch after the DC terminal is connected. Connect the AC terminal to the AC side of the inverter, the AC side is equipped with Three phase AC terminals that can be conveniently connected. Flexible cords are recommended for easy installation. The are as shown in Table 5.2.



Warning:

Prohibit using a single circuit breaker for multiple inverters, prohibit the connection of load between inverter circuit breakers.

| Model | Cable CSA | Cable outer dia | AWG | Breaker | Max cable length |
|--|------------------|-----------------|-----|----------|------------------------------|
| SUN-3K/4K/5K/6K /7K/8K/9K/10K-G05-P SUN-3K-G05-1-P | 4mm ² | 15-18mm | 10 | 20A/400V | Outside cable (3+N+PE)20m |
| SUN-12K-G05-P | 6mm ² | 20-25mm | 10 | 30A/400V | Outside cable (3+N+PE)20m |

Table 5.2 Cable information

The AC output connector is divided into three parts: matching socket, sleeve and sealingsleeve, as shown in picture 5.7, the steps are as follows:

Step 1: Remove the cable sealing ring and sleeve in sequence from the AC connector.

Step 2: Use strippers to strip the protective sheath and insulation layer of the AC cable to the right length, as shown in Picture 5.8.

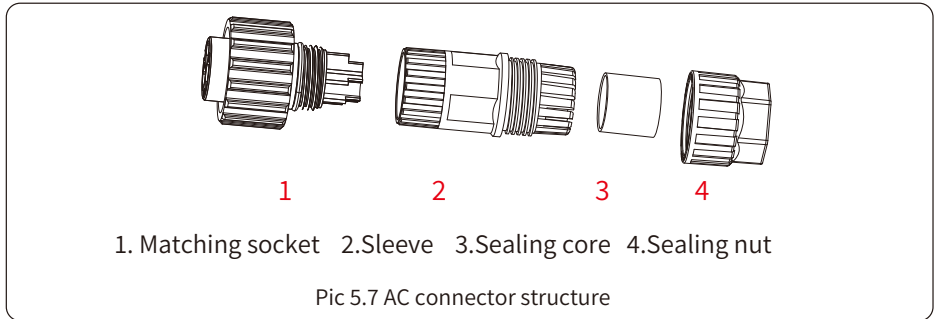

Step 3: Insert the cable (L1, L2, L3, N, PE) into the sealing sleeve.

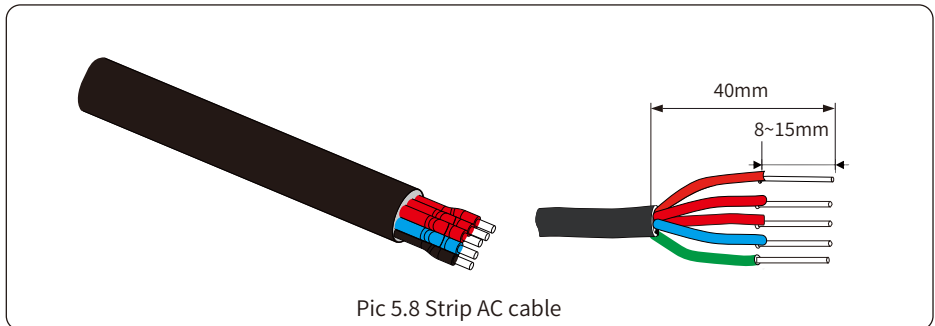

Warning:

Be careful to distinguish the L1, L2,L3,N and PE of the AC cables.

Step 4: Use the hexagon screwdriver, loosen the bolts of the socket in turn, and insert each cable core into the corresponding jack, and set each screw. The connection hole of AC connection terminal labeling is shown in Picture 5.9.

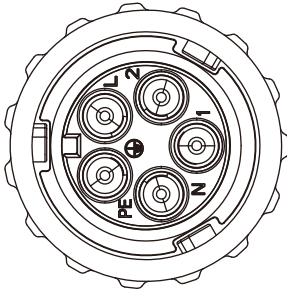

Pic 5.9 AC Connector Hole Pattern

Step 5: Set the sleeve and sealing ring in place.

Step 6: Connect the terminals to the inverter as shown in picture 5.10.

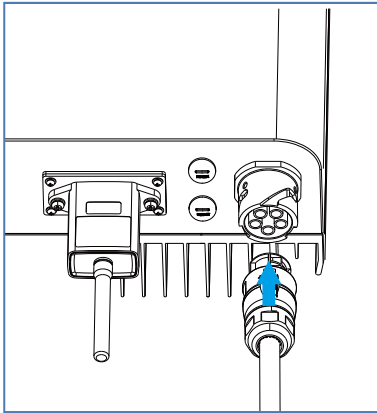

Pic 5.10 AC input connection

5.4 The connection of the ground line

Good grounding is good for resisting surge voltage shock and improving EMI performance. Therefore, before connecting AC, DC and communication cables, you need to ground the cable firstly. For a single system, just ground the PE cable. For multiple machine systems, all PE cables of the inverter need to be connected to the same grounding copper platoon to ensure the equipotential connection. The installation of the shell ground wire is shown as picture 5.11.

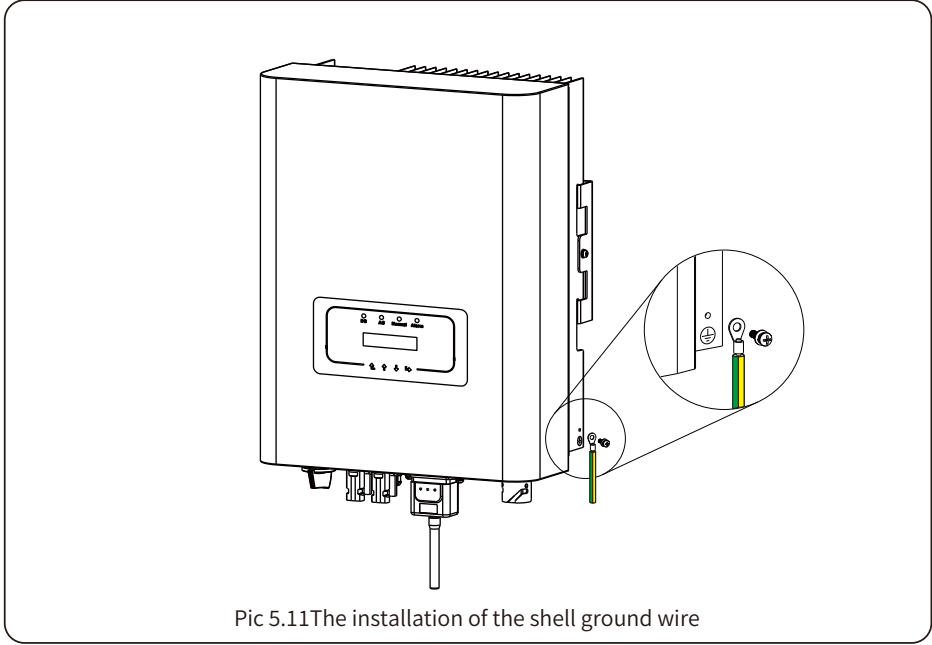

Pic 5.11The installation of the shell ground wire

| Model | Wire Size | Cable(mm ²) | Torque value(max) |
|-----------------|-----------|-------------------------|-------------------|
| 3/4/5/6/7/8/9KW | 13AWG | 2.5mm ² | 8.5Nm |
| 10/12KW | 12AWG | 3mm ² | 8.5Nm |



Warning:

Inverter has built-in leakage current detection circuit, If an external leakage current protection device is connected, its operating current must be greater than 300 mA or higher, otherwise inverter may not work properly.

5.5 Max. over current protection device

In order to protect the inverter AC connection, it is recommended to install a circuit breaker to prevent overcurrent. See table 5.3 below.

| Inverter | Rated output voltage(V) | Rated output current(A) | Current for protection device(A) |
|----------------|-------------------------|-------------------------|----------------------------------|
| SUN-3K-G05-1-P | 220/230 | 4.5/4.3A | 20 |
| SUN-3K-G05-P | 220/230 | 4.5/4.3A | 20 |
| SUN-4K-G05-P | 220/230 | 6.1/5.8A | 20 |
| SUN-5K-G05-P | 220/230 | 7.6/7.2A | 20 |
| SUN-6K-G05-P | 220/230 | 9.1/8.7A | 20 |
| SUN-7K-G05-P | 220/230 | 10.6/10.1A | 20 |
| SUN-8K-G05-P | 220/230 | 12.1/11.6A | 20 |
| SUN-9K-G05-P | 220/230 | 13.6/13.0A | 20 |
| SUN-10K-G05-P | 220/230 | 15.2/14.5A | 20 |
| SUN-12K-G05-P | 220/230 | 18.2/17.4A | 30 |

Table 5.3 Recommended current protector specifications

5.6 Inverter monitoring connection

Inverter has the function of wireless remote monitoring. The inverter with Wi-Fi function is equipped with Wi-Fi Plug to connect the inverter and network. Wi-Fi Plug's operation, installation, Internet access, APP downloading and other processes are detailed in the instructions.

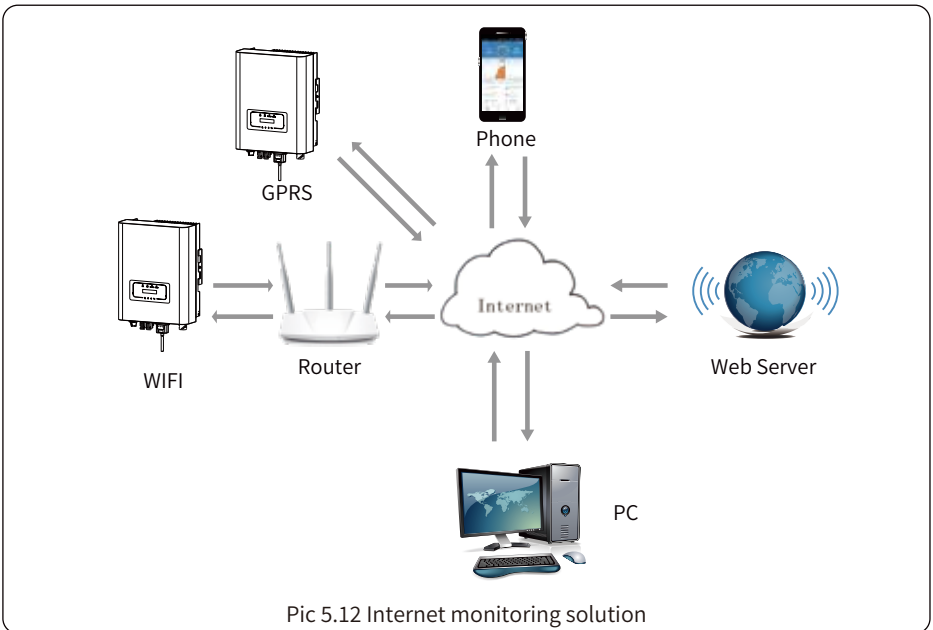

Pic 5.12 Internet monitoring solution

5.7 Installation of datalogger

When installing the WiFi stick, tear off the sealing strip on the inverter. Insert the datalogger into the interface and fix it with a screw. The configuration of the datalogger needs to be performed after various electrical connections have been completed and the inverter DC power on. When the inverter is on the DC power, it is determined whether the datalogger is normally electrified (The LED light shines out of the shell).

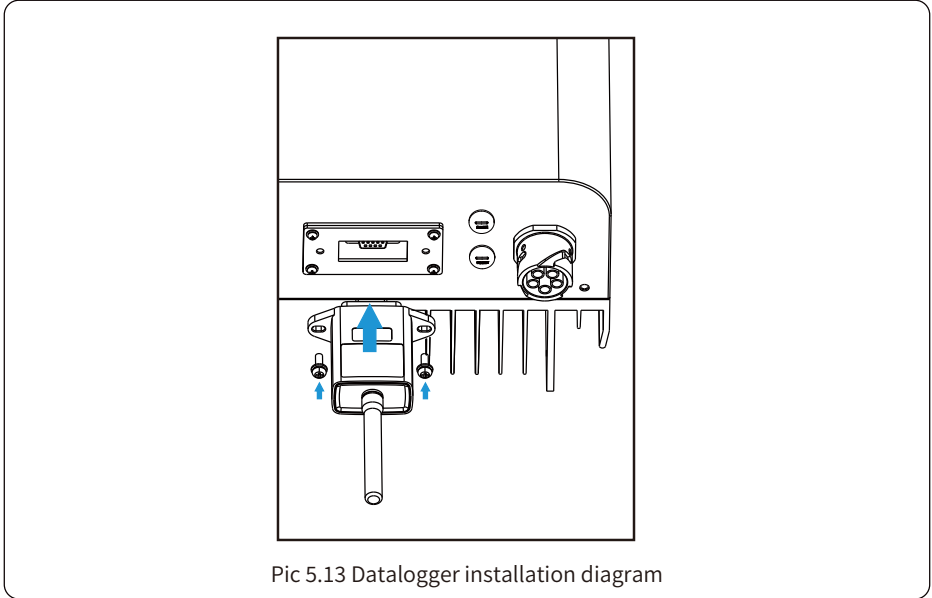

Pic 5.13 Datalogger installation diagram

5.8 Configuration of datalogger

For the configuration of datalogger, please refer to illustrations of the datalogger.

6. Startup and Shutdown

Before starting the inverter, make sure that the inverter can meet the following conditions, otherwise it may result in fire or damage to the inverter. In this case, we do not undertake any responsibility. At the same time, to optimize the system configuration, it is recommended that the two inputs be connected to the same number of photovoltaic modules.

- a). The maximum open circuit voltage of each set of photovoltaic modules shall not exceed 1000Vdc under any conditions.
- b). Each input of the inverter better use the same type of photovoltaic module in series.
- c). Total output power of PV shall not exceed the maximum input power of inverter, each photovoltaic modules shall not exceed the rated power of each channel.

6.1 Start up the inverter

When starting up the three phase string inverter, should follow steps below:

1. Starting switch on the AC breaker.
2. Turn on the DC switch of the photovoltaic module, and if the panel provides sufficient starting voltage and power, the inverter will start.
3. The inverter will first check the internal parameters and the grid parameters, while the liquid crystal will show that the inverter is self-checking.
4. If the parameter is within acceptable range, the inverter will generate energy. NORMAL indicator light is on.

6.2 Inverter Shutdown

Must follow below steps while shutting down the inverter:

1. Switch off the AC breaker.
2. Wait for 30 seconds, turn off the DC switch (if any), or simply disconnect the DC input connector. The inverter will close the LCD and all LED within two minutes.

6.3 Anti-PID Function(option)

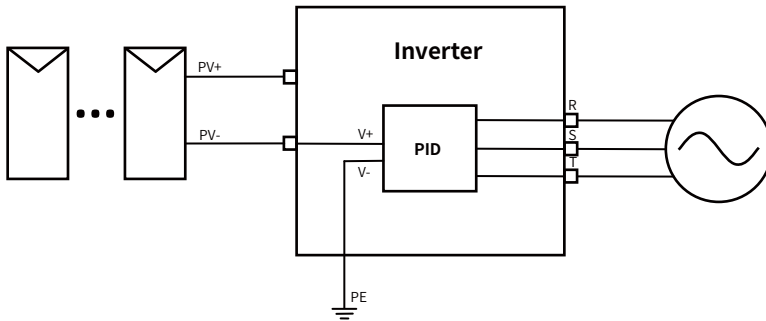

The Anti-PID module repairs the PID effect of the PV module at night. The PID module always runs when connected to AC.

If maintenance is required and turn off the AC switch can disable the Anti-PID function.



Warning:

The PID functionality is automatic. When the DC bus voltage is below 50VDC, the PID module will create 450VDC between the PV and ground. No control and equipment are required.



Warning:

If you need to maintain the inverter, Please turn off the AC switch first, then turn off the DC switch, and wait 5 minutes before you do other operations.

7. Zero-export function via energy meter

There're two kinds of energy meters for this series inverter. First type is Eastron SDM630-Modbus V2 which is able to measure the Max. 100A current directly. More details please refer to Pic 7.1 & 7.2. For the Eastron SDM630 MCT 40mA, it needs external CT to measure the current. The CT power range is from 5A-2000A. More details about the Eastron SDM630 MCT, please refer to Pic 7.3 & 7.4. Also, the CHNT meter DTSU666 is supported, it can measure the Max. 80A current directly. More details about the DTSU666, please refer to Pic 7.1 & 7.16.

When you are reading this, we believe that you have completed the connection according to the requirements of chapter 5, if you have been running your inverter at this time, and you want to use the zero-export function, please turn off AC and DC switch of the inverter, and wait for 5 minutes until the inverter completely discharged. Please follow below Picture 7.1 to connect the energy meter.

For system wiring diagram, the red line refers to L line (L1, L2, L3), the black line refers to the neutral line (N). Connecting energy meter RS485 cable to inverter's RS485 port. It's recommended to install an AC switch between the inverter and the utility grid, the specs of the AC switch are determined by the power of load.

If there is no integrated DC switch inside the inverter you purchased, we commend you to connect the DC switch. The voltage and current of the switch depend on the PV array you access.



Eastron SDM630-Modbus V2

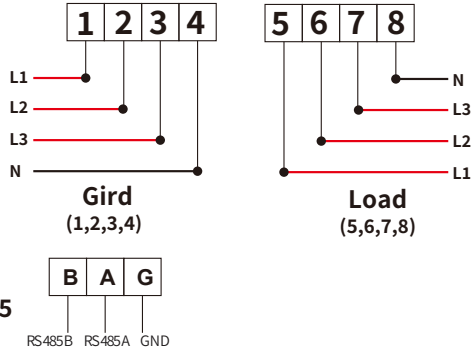

RS 485

Pic 7.1 Eastron meter

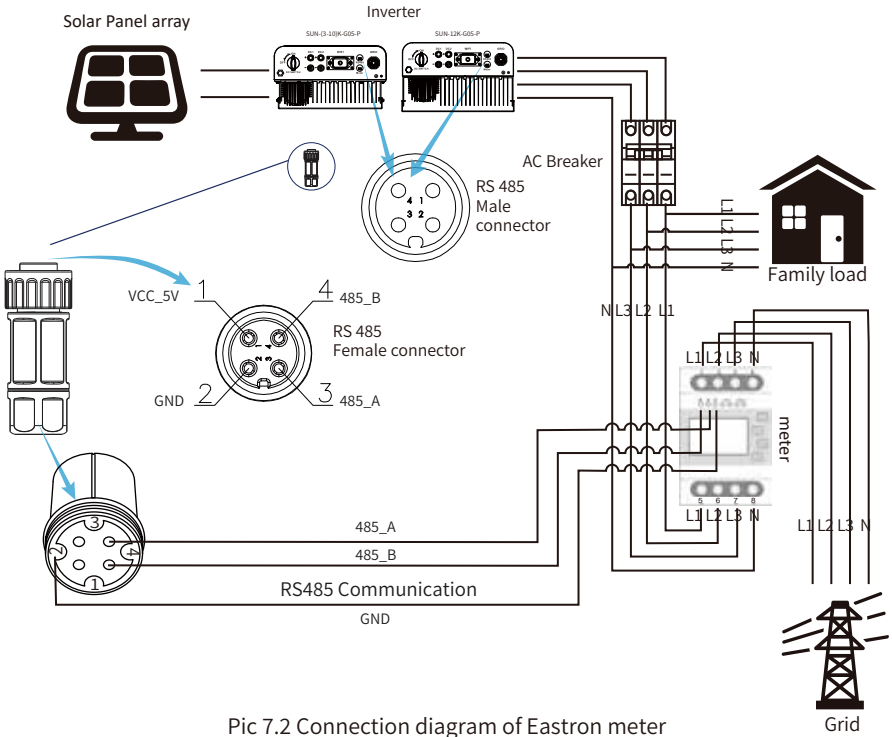

Pic 7.2 Connection diagram of Eastron meter



Warning:

In final installation, breaker certified according to IEC 60947-1 and IEC 60947-2 shall be installed with the equipment.



Eastron SDM630-Modbus V2

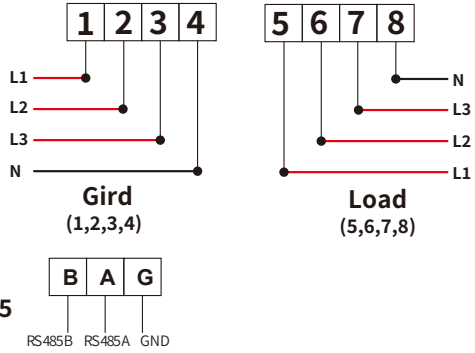

RS 485

Pic 7.3 Eastron meter

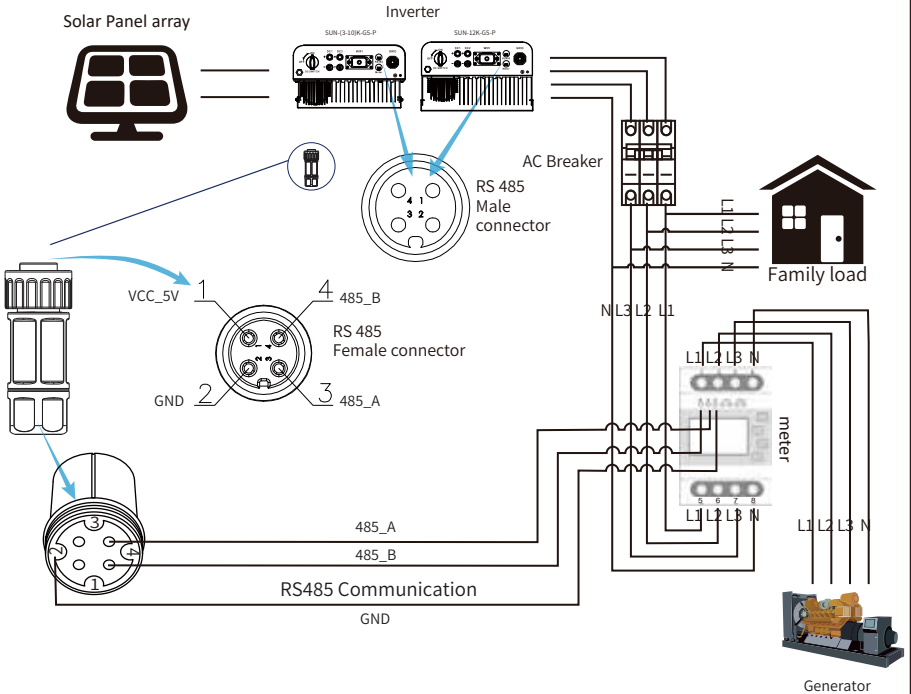

Pic 7.4 Connection diagram of Eastron meter

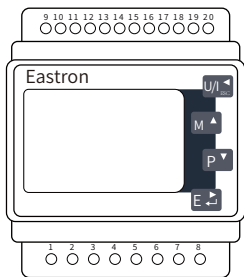

Eastron SDM630MCT

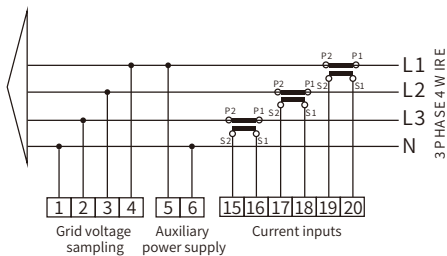

RS 485

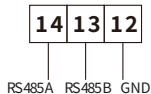

Pic 7.5 Eastron meter

Solar Panel array



Inverter

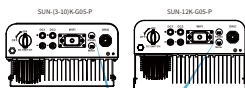

AC Breaker



Family load

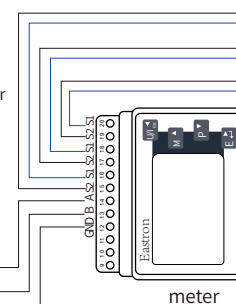
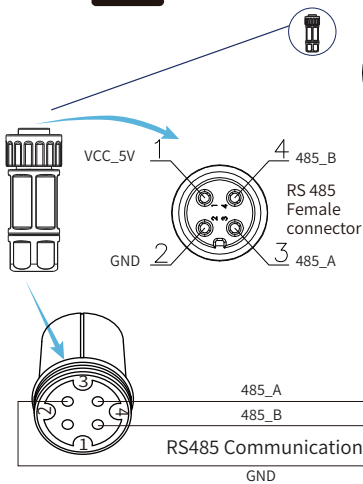

meter

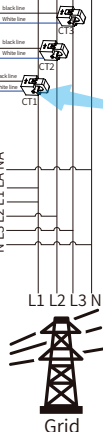

Grid

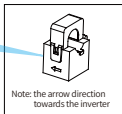

Pic 7.6 Connection diagram of Eastron meter

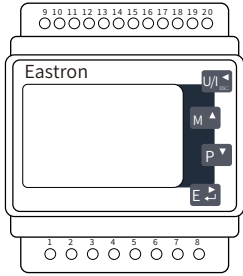

Eastron SDM630MCT

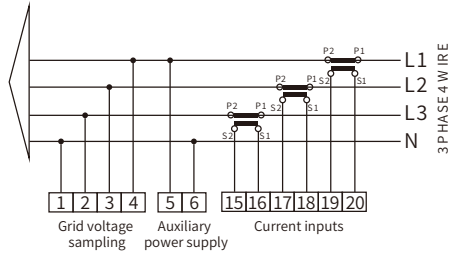

RS 485

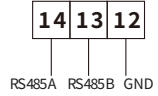

Pic 7.7 Eastron meter

Solar Panel array

Inverter

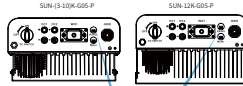

AC Breaker



Family load

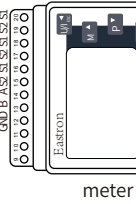
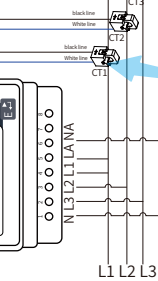
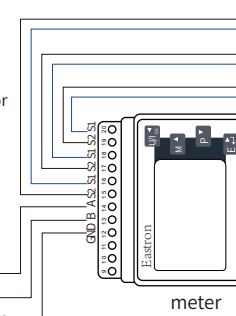
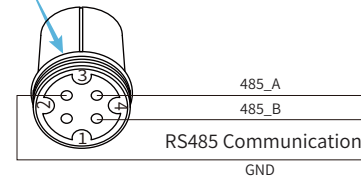
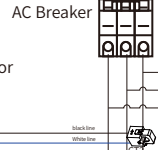
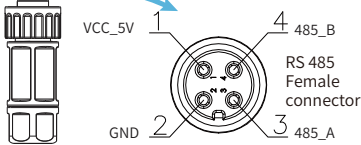

meter

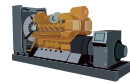

Generator

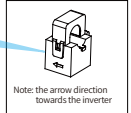

Pic 7.8 Connection diagram of Eastron meter

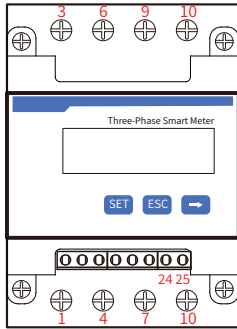

CHNT DTSU666

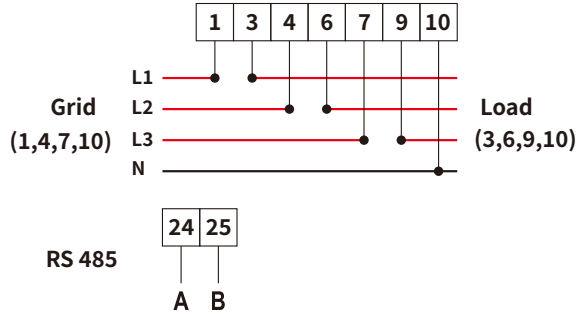

Pic 7.9 CHNT meter

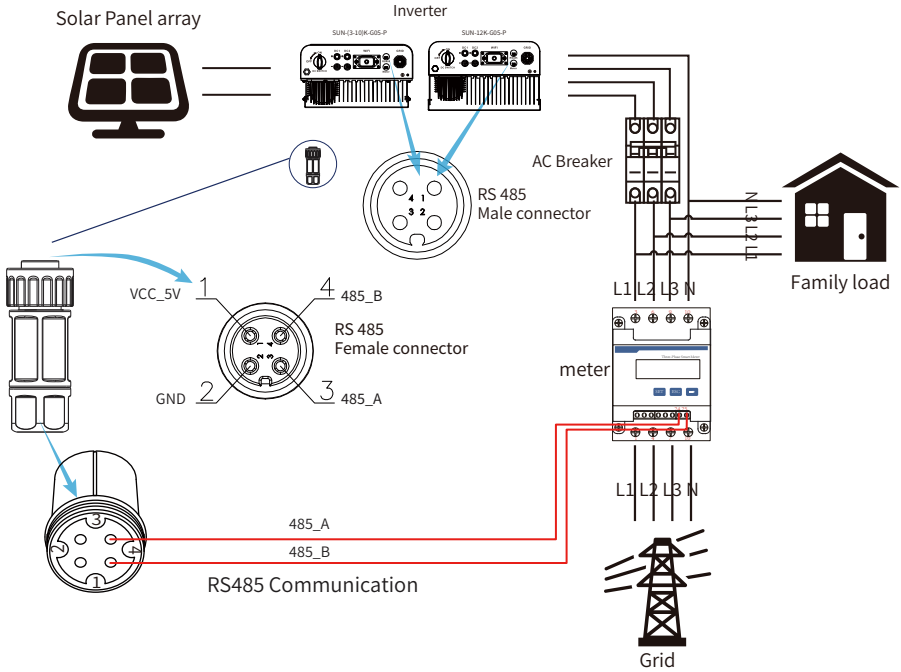

Pic 7.10 Connection diagram of CHNT meter

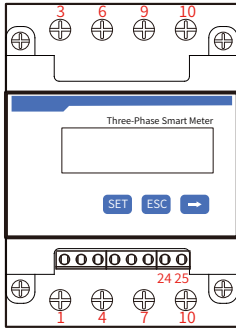

CHNT DTSU666

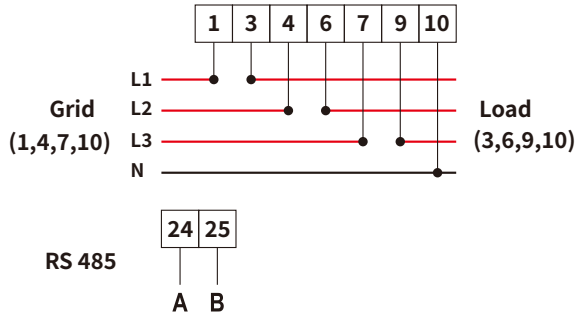

Pic 7.11 CHNT meter

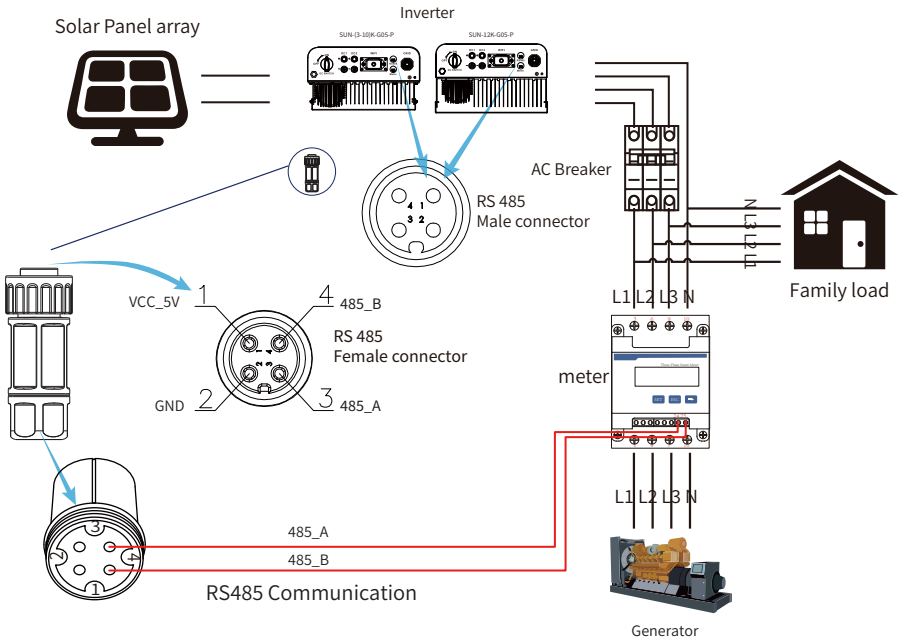

Pic 7.12 Connection diagram of CHNT meter

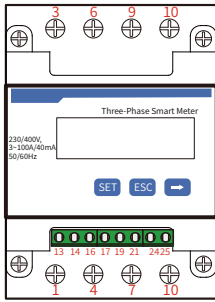

CHNT DTSU666
3x230/400V
100A/40mA

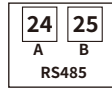
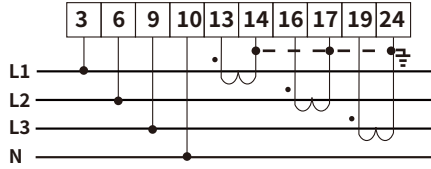

Phase C current = 5.002A



Pic 7.13 CHNT meter

Solar Panel array

Inverter

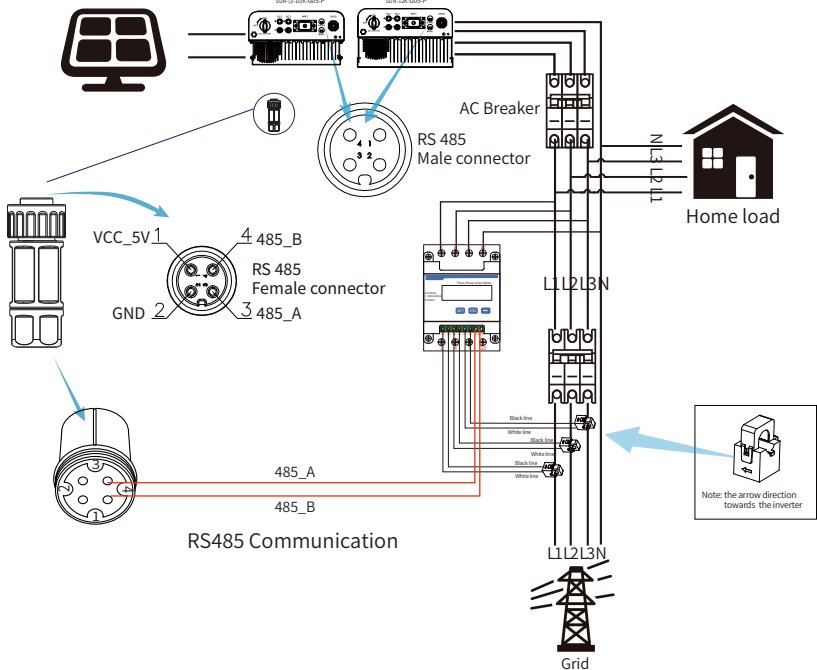

Pic 7.14 Connection diagram of CHNT meter

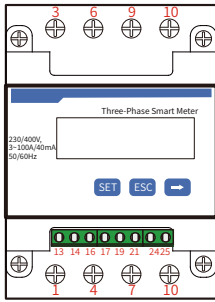

CHNT DTSU666
3x230/400V
100A/40mA

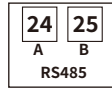
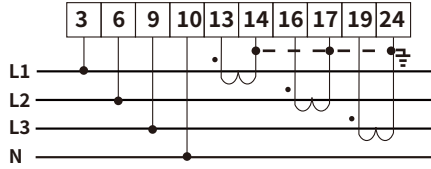

Phase C current =5.002A

Pic 7.15 CHNT meter

Solar Panel array

Inverter

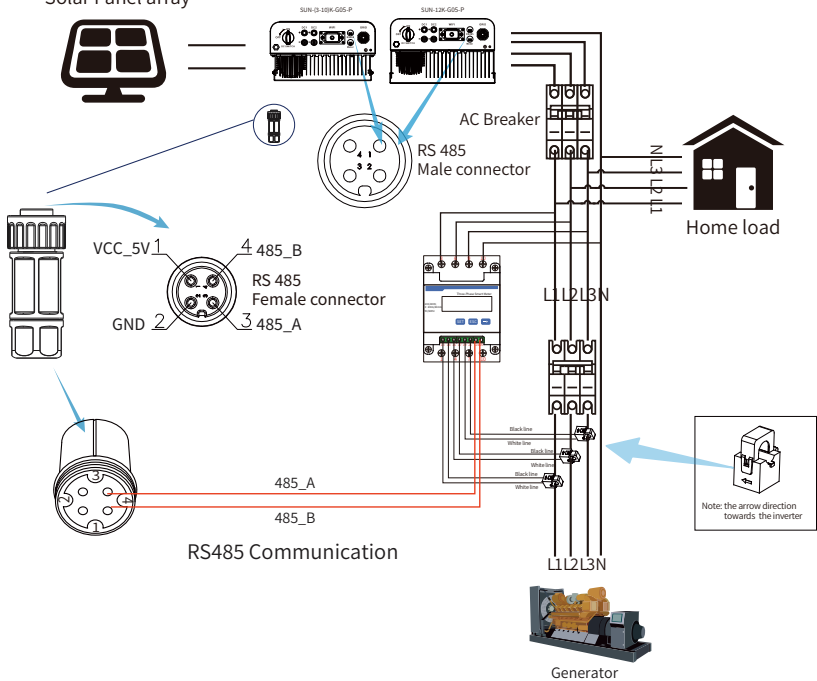

Pic 7.14 Connection diagram of CHNT meter

7.1 Multiple strings and parallel connection meters

This application is that when the string inverters work in parallel, there is only one power grid and one load, and only one meter can be connected to prevent reverse current, so only this many-to-one anti-reverse current connection can be connected.

If there' s several inverters in a plant, also it can use 1pcs meter to realize zero export function. For example,if there' s 3pcs inverter in the system with 1pcs meter.We need to setup 1pcs inverter as the master and others setup as slaves. And, all of them need to connect to the meter via RS485. Below is the system diagram and configuration of the system.

| | | | |
|-----------|----------|----------|--------|
| Meter | OFF << | Exp_Mode | AUG << |
| Limiter | OFF | CT_Ratio | 0 |
| MFR | ACREL | Shunt | OFF |
| FeedIn | 0,0KW << | ShuntQTY | 1 << |
| Generator | ON | G_MFR | CHNT |
| G_CT | 1 << | G_Pout | 0% << |
| G_Cap | 0,0KW | | |
| Back<< | | | |

Pic 7.17 Meter function

| Name | Description | Range |
|-----------|--|-----------------------|
| Exp_Mode | AVG: Average power of three phase is zero exported. MIN: Phase with minimum load power is zero exported, while the other two phase may be in purchase mode. | AVG/MIN |
| CT_Ratio | CT ratio of power grid side meter when extern CT is applied. | 1-1000 |
| MFR | Manufacturer of the grid side meter. Modbus Address of it should be set as 01. | AUTO/CHNT/ EASTRON |
| Feedin | Percentage of the Feed in power exported to the grid. | 0-110% |
| Shunt | Parallel mode. Set one inverter as Master, others are Slave. ONLY need to set the master, Slave will follow the settings in the master. | OFF/Master/ Slave |
| ShuntQTY | Number of inverters in parallel | 1-16 |
| Generator | DG side meter function Enable/Disable | ON/OFF |
| G.CT | CT ratio of power DG side meter when extern CT is applied. | 1-1000 |
| G.MFR | Manufacturer of the DG side meter. Modbus Address of it should be set as 02. | AUTO/CHNT/ EASTRON |
| G.Cap | Capacity of the DG. | 1-999kW |

Note: Select Meter option in Run Param and long press ENTER button to enter this Meter Setting page.



Eastron SDM630-Modbus V2

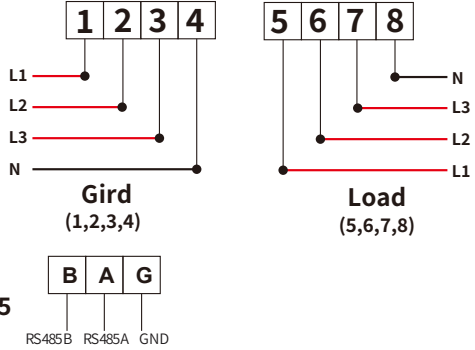

Pic 7.18 Eastron meter

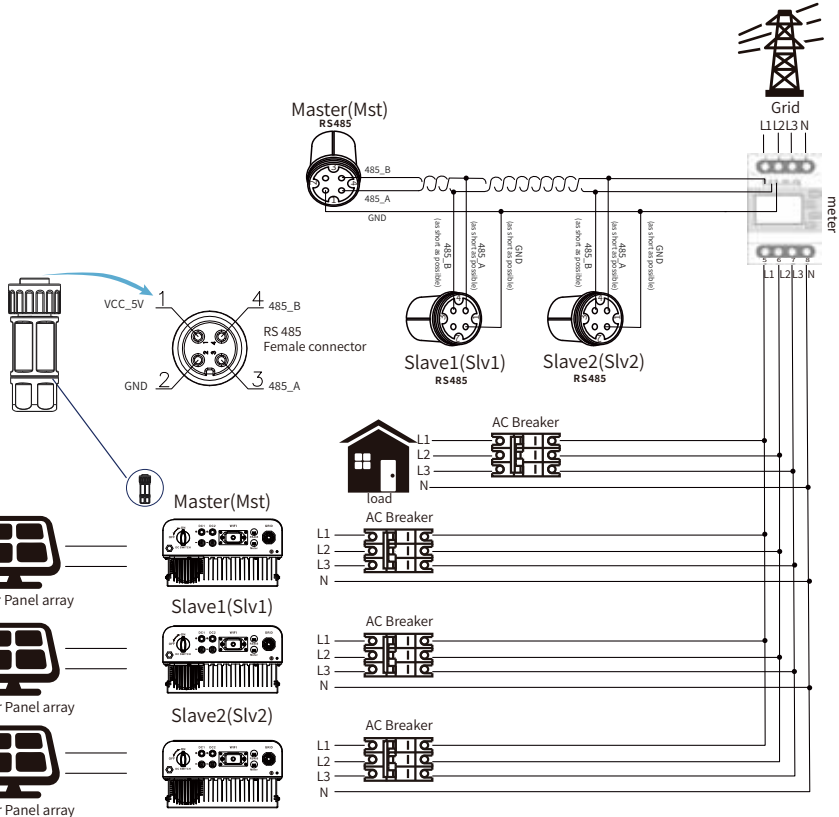

Pic 7.19 Eastron Connection diagram(The pass-through table)

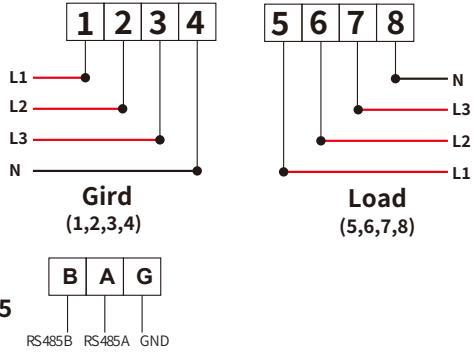

Eastron SDM630-Modbus V2

Pic 7.20 Eastron meter

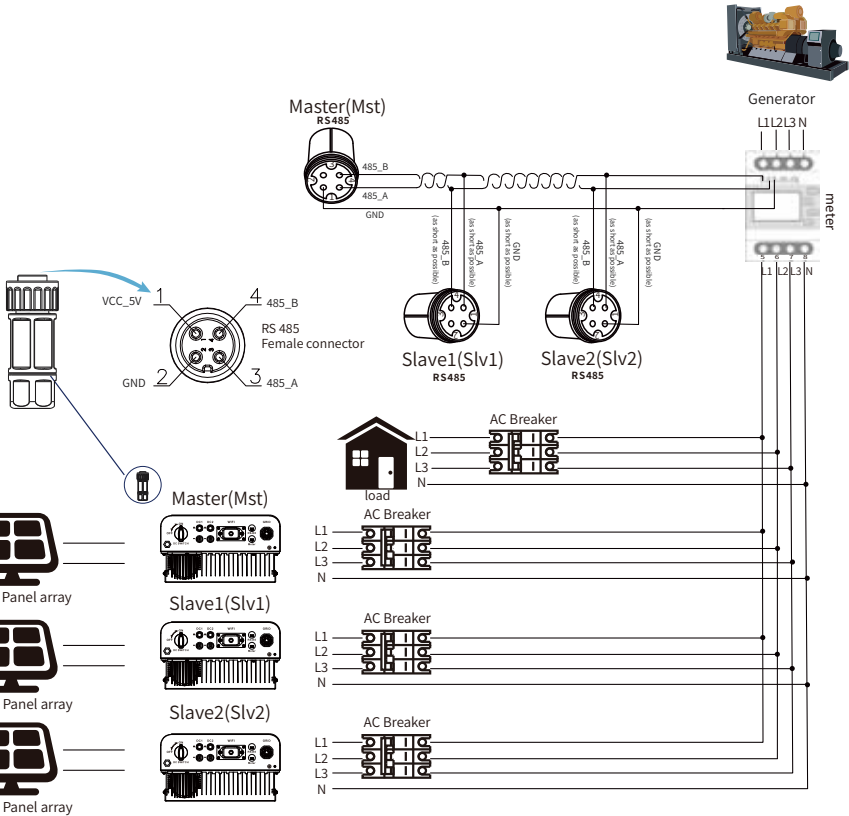

Pic 7.21 Eastron Connection diagram(The pass-through table)

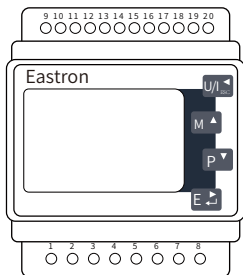

Eastron SDM630MCT

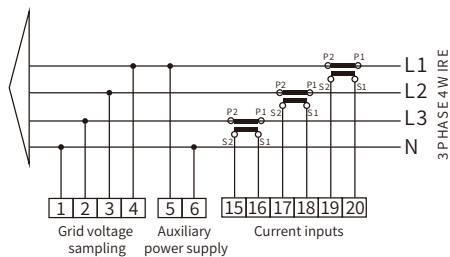

RS 485

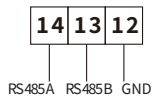

Pic 7.22 Eastron meter

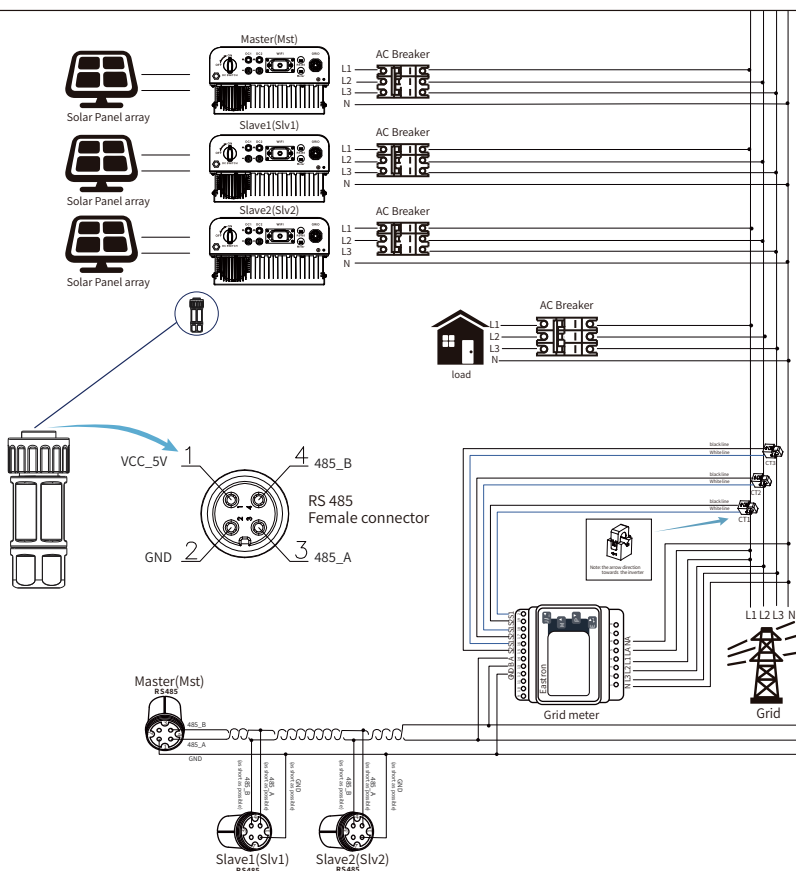

Pic 7.23 Connection diagram(Three-phase electricity)

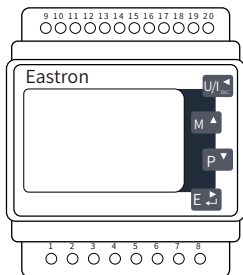

Eastron SDM630MCT

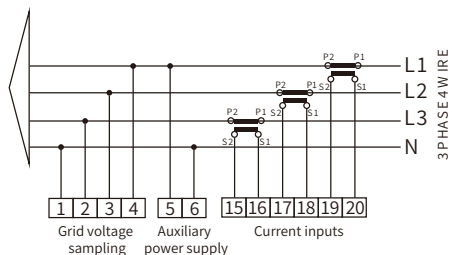

RS 485

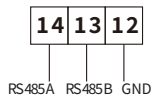

Pic 7.24 Eastron meter

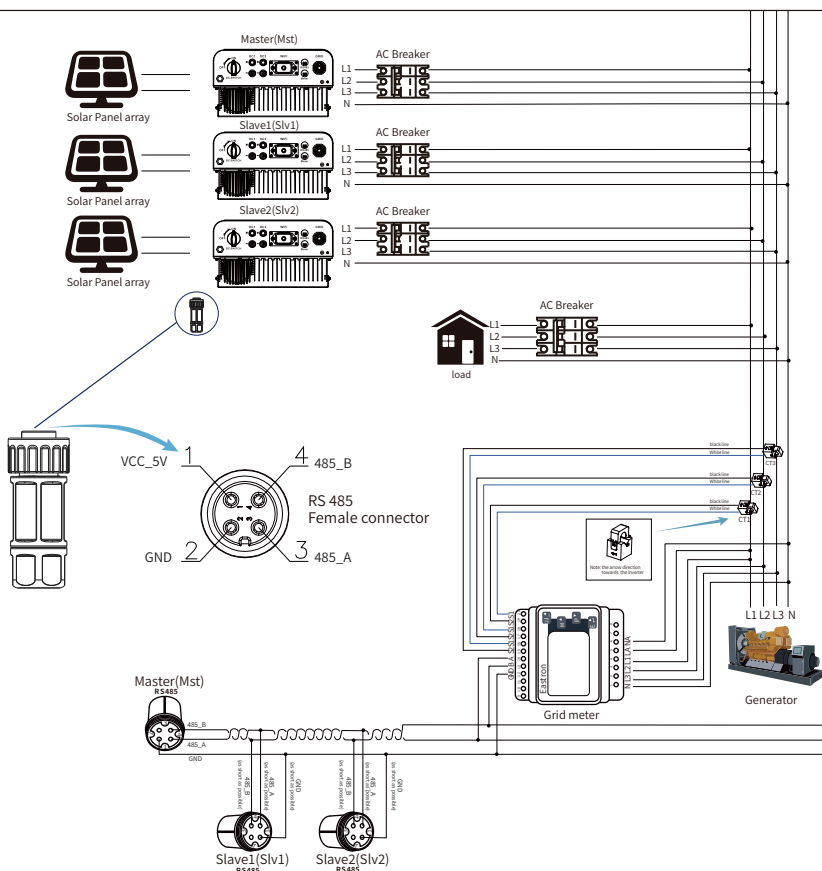

Pic 7.25 Connection diagram(Three-phase electricity)

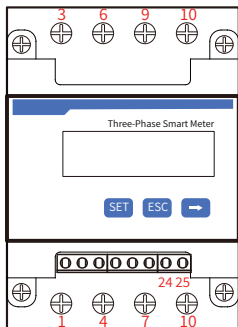

CHNT DTSU666

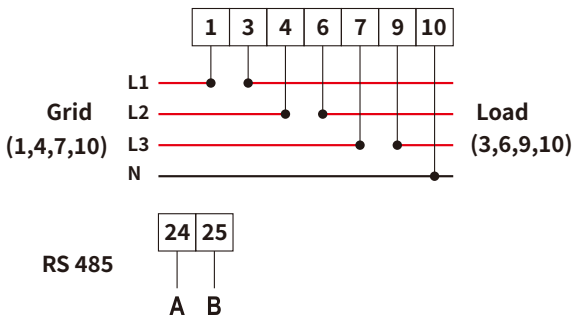

Pic 7.26 CHNT meter

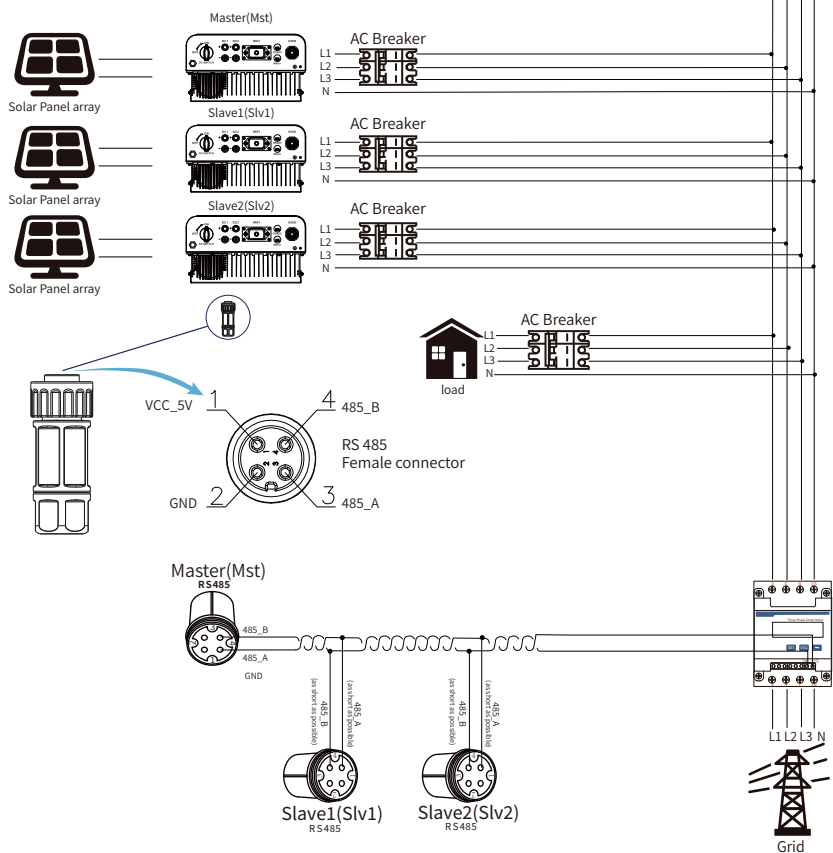

Pic 7.27 CHNT Connection diagram(The pass-through table)

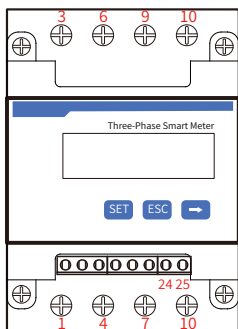

CHNT DTSU666

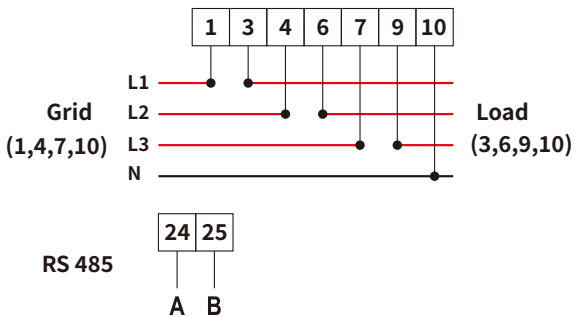

Pic 7.28 CHNT meter

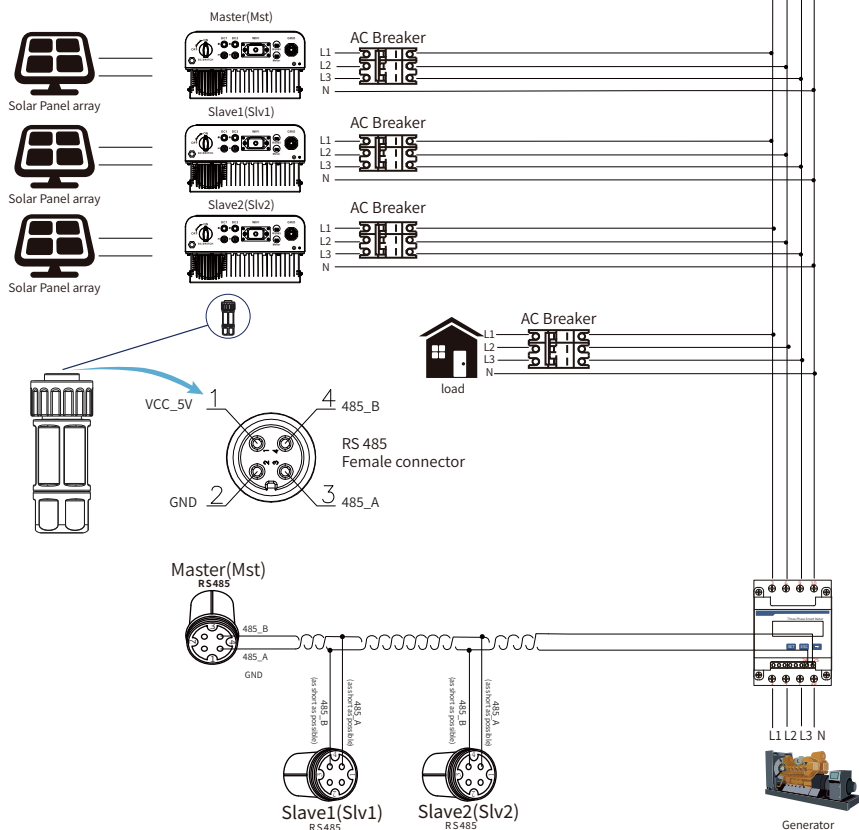

Pic 7.29 CHNT Connection diagram(The pass-through table)

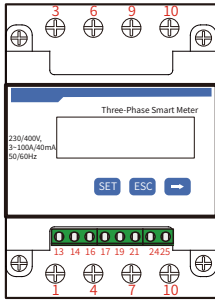

CHNT DTSU666
3x230/400V
100A/40mA

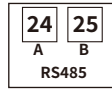
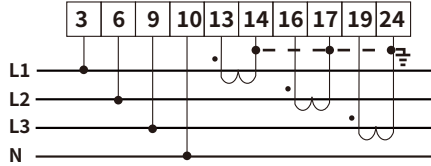

Phase C current =5.002A



Pic 7.30 CHNT meter

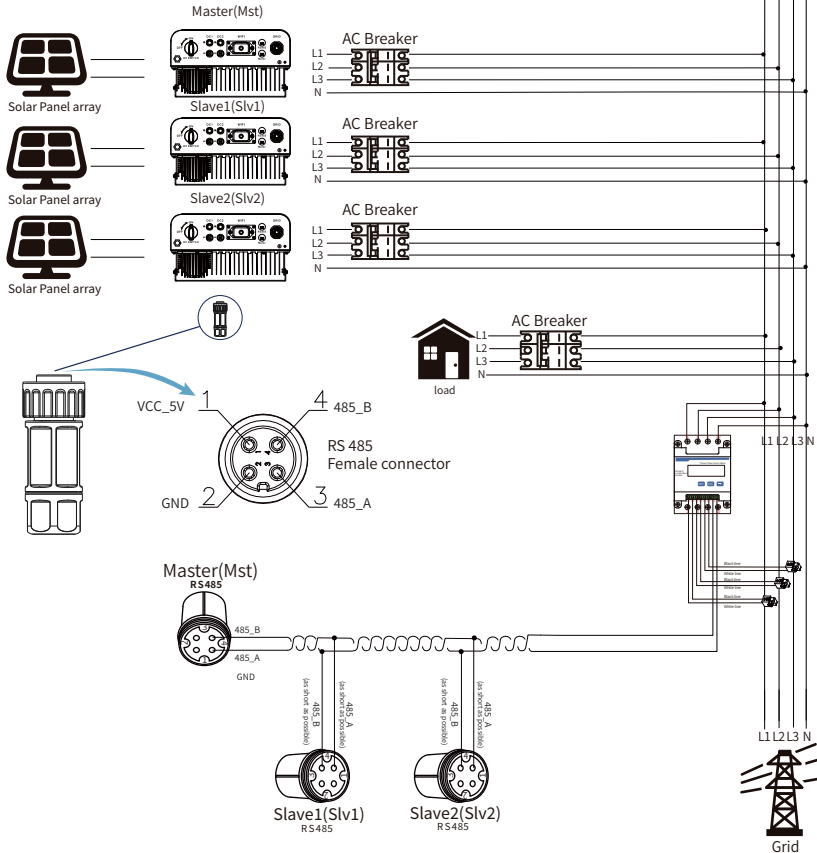

Pic 7.31 CHNT Connection diagram(The pass-through table)

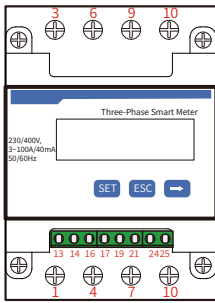

CHNT DTSU666
3x230/400V
100A/40mA

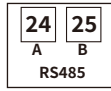
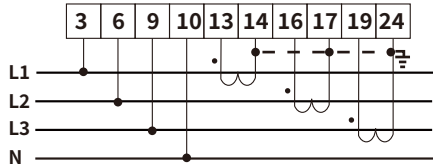

Phase C current = 5.002A

Pic 7.32 CHNT meter

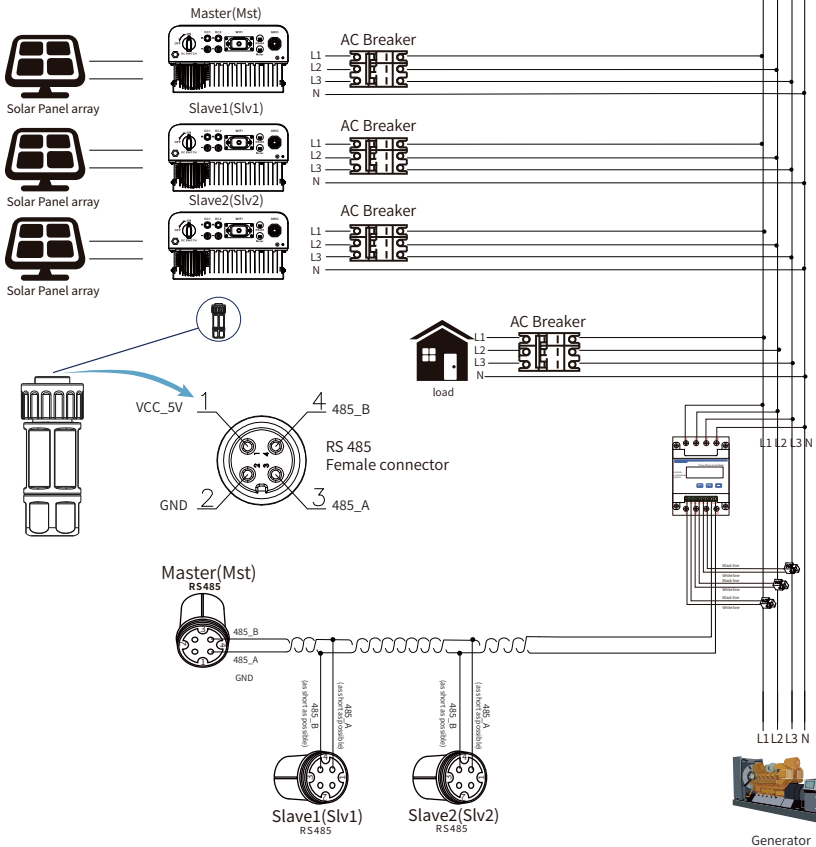

Pic 7.33 CHNT Connection diagram(The pass-through table)

7.2 Use of zero-export function

When the connection is completed, the following steps should be referred to use this function:

1. Turn on the AC switch.
2. Turn on the DC switch, waiting for the inverter's LCD is turned on.
3. Press Enter button on the LCD panel in the main interface into the menu options, select [parameter setting] to enter setup submenu, and then select [running parameters] as shown in picture 7.34, at this time please input the default password 1234 through pressing the button [up down, enter], enter the operation parameter setting interface, shown as picture 7.35.



Pic 7.34 Parameter setting



Pic 7.35 Meter switch

4. Operate the button [up down], move setting cursor to energy meter and press the button [enter]. At this time you can turn on or turn off the energy meter by choosing [up down] button, please press [enter] button to confirm when setting done.
5. Move the cursor to [OK], press [enter] to save the settings and exit the running parameters page, otherwise the settings are invalid.
6. If set up successfully, you can return to the menu interface, and display the LCD to [home page] by press the [up down] button. If it displays [meter power XXW], the zero-export function setting is completed. Shown as picture 7.36.



Pic 7.36 Zero-export function via energy meter turn on

7. Meter power XXW shows positive means grid is supplying the load, and no power fed into grid. if meter power shows negative, it means PV energy is being sold to grid or energy meter wiring connection has problem.
8. After properly connection is done, wait for inverter starting. If the power of the PV array meets the current power consumption, the inverter will keep a certain output to counteract the power of the grid without backflow .

7.3 Notes while using zero export function

For your safety and the operation of limiter function of the inverter, we put forward the following suggestions and precautions:



Safety Hint:

Under zero export mode we strongly recommend that the two PV arrays are formed by the same number of PV panels of the same size, which will make the inverter more responsive to limit the power.



Safety Hint:

While the utility power is negative and inverter has no output power, that means the orientation of the current sensor is wrong, please turn off the inverter and change orientation of the current sensor.

7.4 How to browse the load power of your PV grid-tie plant on monitoring platform?

If you want to browse load power of the system and how much energy (KWH) does it export to grid(inverter output power is used to power the load firstly and then the surplus energy will feed into grid). You also need to connect the meter according to above diagram. After the connection completed successfully, the inverter will show the load power on the LCD. **But please don't setup "Meter ON"** . Also, you will be able to browse the load power on the monitoring platform. The plant setting method as below description.

Firstly, go to the solarman platform(<https://pro.solarmanpv.com>, this link is for solarman distributor account; or <https://home.solarmanpv.com>, this link is for solarman end user account;), plant home page and click "edit" .

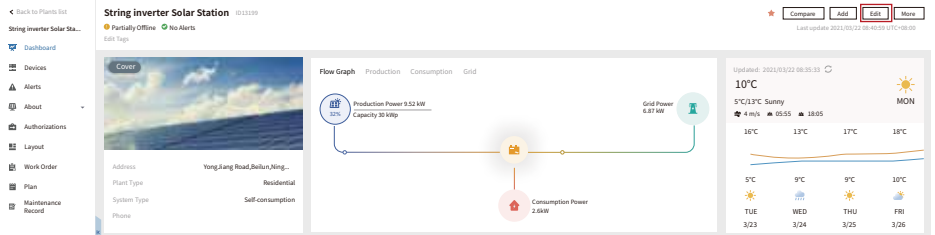

And then choose your system type as “Self-consumption”

Edit Plant Cancel Done

Basic Info
System Info
Yield Info
Owner Info

Address: Yongjiang Road, Beilun, Ningbo, 315806, China

Coordinates: Longitude 121 46 19.03 Latitude 29 53 36.11

Time Zone: (UTC+08:00) Beijing,Chongqing,Hong Kong, Urumqi

Creation Time: 2020/04/08

System Info Collapse

Plant Type: Residential

System Type: **Self-consumption**

Capacity (Wp): 30

Address: 0-360

Secondly, go to plant page, if it shows the PV power, load power and grid power, which means the configuration is correct.

String inverter Solar Station 013399 Compare All Edit More
Last update: 2021/03/22 09:40:53 (UTC+08:00)

Partially Offline No Alerts

Dashboard

Devices Alerts About Authorizations Layout Work Order Maintenance Record

Cover

Address: Yongjiang Road, Beilun, Ning...
Plant Type: Residential
System Type: Self-consumption
Phone:

Flow Graph Production Consumption Grid

Production Power 9.52 kW
Capacity 30 kWp

Grid Power 6.87 kW

Consumption Power 2.6kW

Updated: 2021/03/22 08:35:13
10°C
5°C 11°C Sunny
4 h/m 55-55 18:05
MON
16°C 13°C 17°C 18°C
5°C 9°C 9°C 10°C
TUE WED THU FRI
3/23 3/24 3/25 3/26

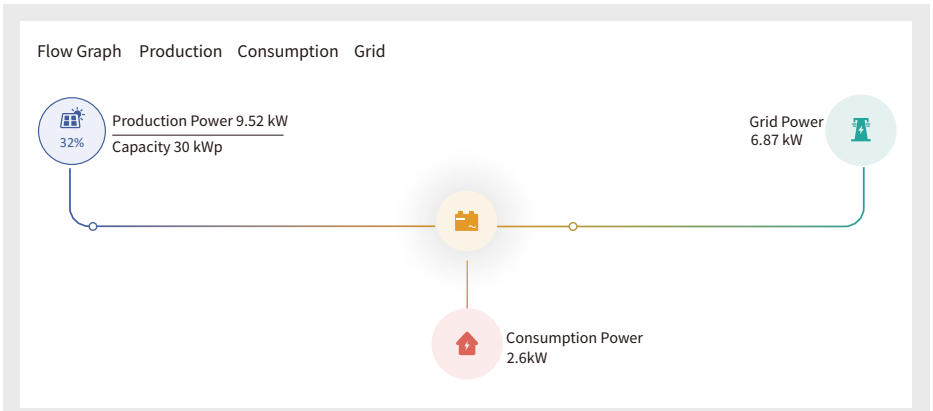

8. General Operation

During normal operation, the LCD shows the current status of the inverter, including the current power, total generation, a bar chart of power operation and inverter ID, etc. Press the Up key and the Down key to see the current DC voltage, DC current, AC voltage, AC current, inverter radiator temperature, software version number and Wifi connection state of the inverter.

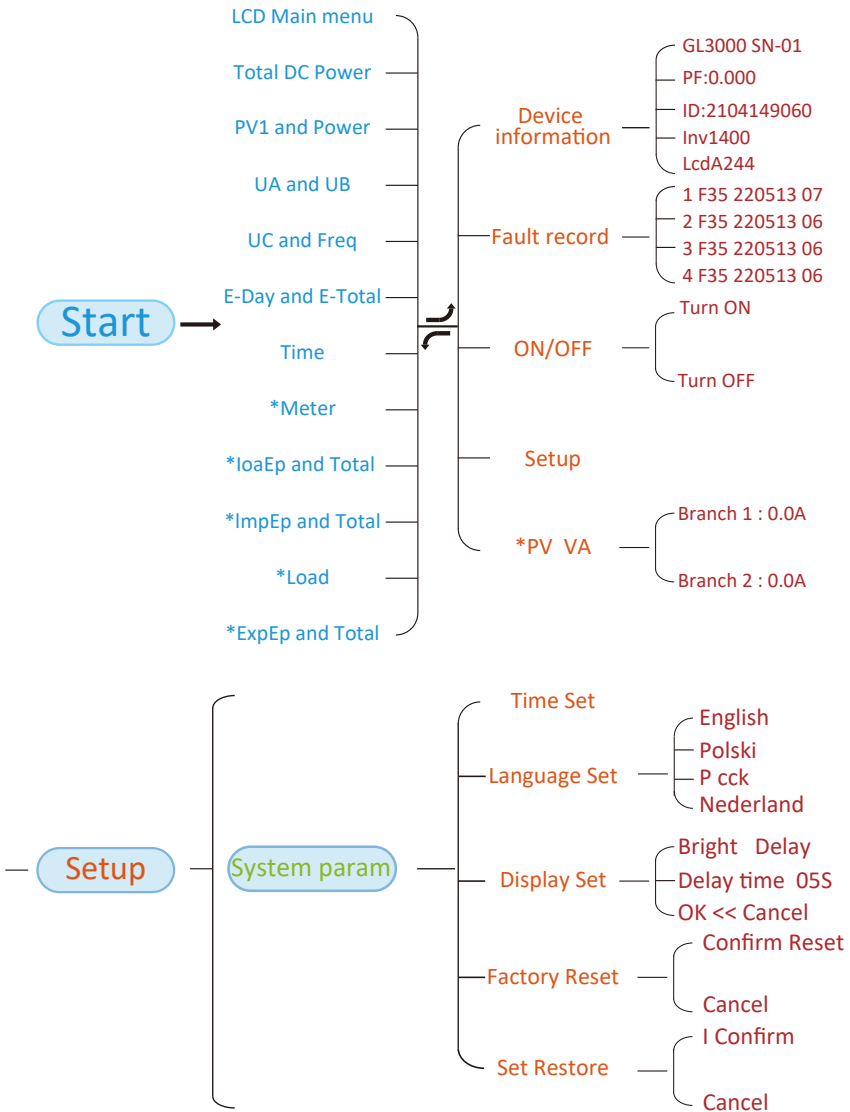

Setup

Running param

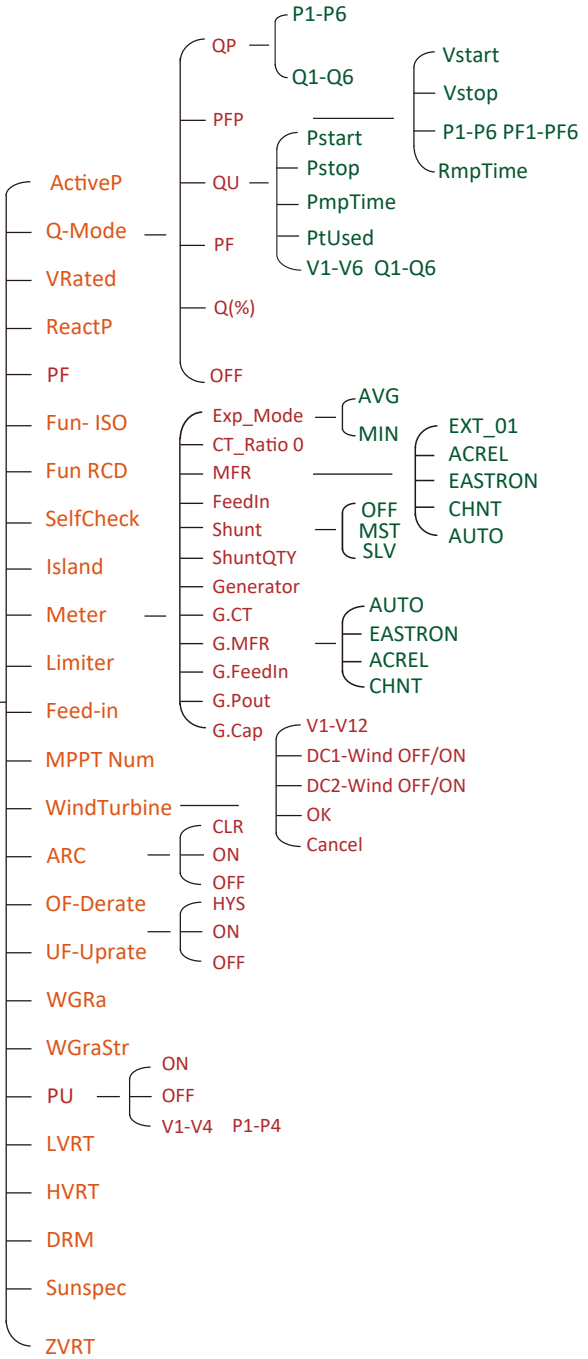

***Note: These parameters will be available after the meter is connected successfully. Otherwise, it won't show.**

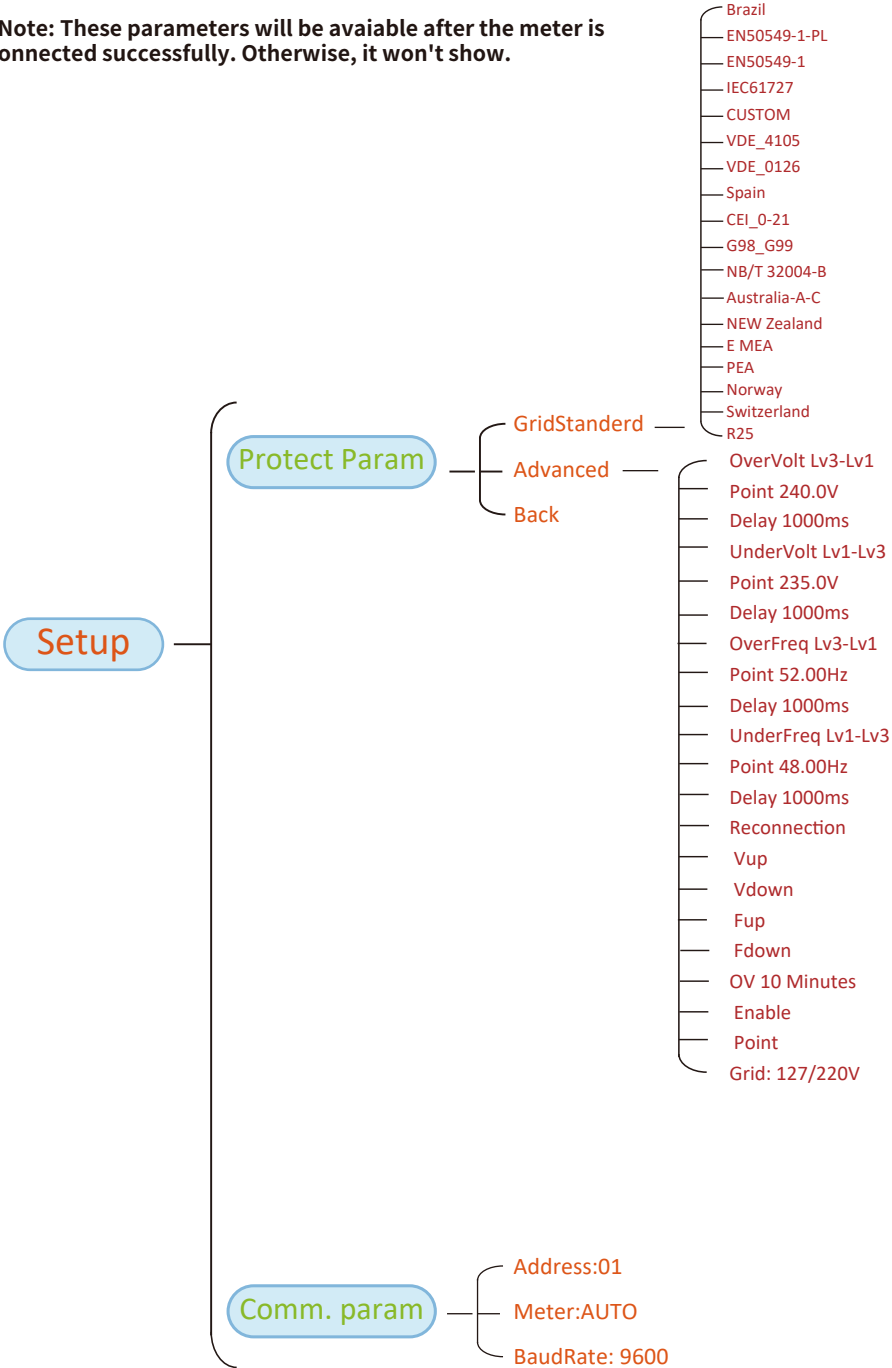

Pic 8.1 LCD operation flow chart

8.1 The initial interface

From the initial interface, you can check PV power, PV voltage, grid voltage, inverter ID, model and other information.



Pic 8.2 The initial interface

Press UP or Down, you can check inverter DC voltage, DC current, AC voltage, AC current and inverter temperature.



Pic 8.3 PV input voltage and current information

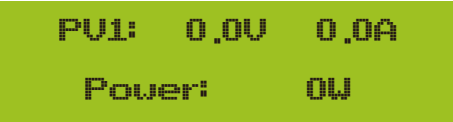

Pic 8.4 Load power



Pic 8.5 Grid voltage and current information



Pic 8.6 Grid voltage and frequency



Pic 8.7 PV generation

E-Day: Daily generation;
E-Total: Total generation.



Pic 8.8 Time



Pic 8.9 Meter power



Pic 8.10 Load consumption

LoadEp: Daily consumption;
Total: Total energy consumption.

```
ImpEp: 0.00KWh
Total : 0.00KWh
```

ImpEp: Daily energy purchased from grid;
Total: Total energy purchased from grid.

Pic 8.11 Electrical energy

```
ExpEp: 0.00KWh
Total : 0.00KWh
```

ExpEp: Daily energy sold to grid;
Total: Total energy sold to grid.

Pic 8.12 Electrical energy

8.2 Submenus in the Main Menu

There are five submenus in the Main Menu.

8.2.1 Device information

You can see the LCD software VerA238 and control board software Ver1400. In this interface, there are parameters such as rated power communication addresses.

| | |
|---|-----------------------------------|
| <pre>Device Info. << Fault Record</pre> | <pre>GL3000 SN-01 PF: 0.000</pre> |
| <pre>ID:2104149060 Inv1400</pre> | <pre>Inv1400 LcdA244</pre> |

Pic 8.13 Device information

8.2.2 Fault Record

It can keep Eight fault records in the menu including time, customer can deal with it depends on the error code.

| | |
|---|--|
| <pre>Device Info. Fault Record <<</pre> | <pre>1 F35 220513 07 2 F35 220513 06</pre> |
| <pre>3 F35 220513 06 4 F35 220513 06</pre> | |

Pic 8.14 Fault Record

8.2.3 ON/OFF setting



Pic 8.15 ON/OFF setting

When the inverter is turned off, it stops working immediately, and go to standby mode and then will go to self-test program again. If it passed the self-test, it will start to work again.

8.2.5 Parameter setting

There are five submenus in the setup. Setting includes system param, run param, protect param, comm: param. All of these information for maintenance reference.



Pic 8.16 Submenus of the parameter setup

8.3 System param setting

System Param includes time set, language set, display set and factory reset.



Pic 8.17 System Param



Pic 8.18 Time



Pic 8.19 Language



Pic 8.20 LCD Screen settings



Pic 8.21 Delay time set



Pic 8.22 Reset to factory setting



Pic 8.23 Set Restore

8.4 Running param set



Warning:

Password required-- only for access-authorized engineer. Un-authorized access may avoid the warranty. The initial password is 1234.



Pic 8.24 Password

| | | | |
|-------------|--------|-----------|---------|
| ActiveP | 0% | Uref | 0,0U |
| Q-Mode | OFF << | ReactP | 0,0% << |
| PF | -1,000 | Fun_RCD | OFF << |
| Fun_ISO | OFF << | SelfCheck | 0S |
| Island | OFF << | Limiter | OFF |
| Meter | OFF | Feed-in | 0% << |
| MPPT Num | 0 | ARC | ON |
| WindTurbine | << | OF-Derate | OFF <- |
| UF-Uprate | OFF <- | UGra | 0,0% << |
| UGra | 0,000% | UGraStr | 0,0% |
| PU | ON | LURT | OFF |
| PowerLim | << | HURT | OFF << |
| DRM | OFF | Sunspec | OFF << |
| Sunspec | OFF << | ZURT | << |

OK**Cancel** <<

Pic 8.25

| Name | Description | Range |
|-------------|---|---------------------------------|
| ActiveP | Adjust the output active power in % | 0-110% |
| Q-Mode | Multiple reactive power control modes | OFF/Q(P)/PF(P) /Q(U)/PF/Q(%) |
| Vref | Grid reference voltage for functions including Q(U),PF(P),P(U)etc. | 80-260V |
| ReactP | Adjust reactive power output in % | -100%~+100% |
| PF | Power Fator | -1-0.8~+0.8-1 |
| Fun_ISO | Insulation resistance detection | ON/OFF |
| Fun_RCD | Residual current detection | ON/OFF |
| Self-check | Inverter's self-check time.The default value 60s | 0-1000s |
| Island | Anti-islanding protection | ON/OFF |
| Meter | If you want to use zero output mode,please set Meter to ON and select OFF to view data only | ON/OFF |
| Feed_IN % | It is used to deploy how much power can be feed in to grid when the inverter works under zero export mode.(For example,Feed_in=50% of the 12KW model and load power is 5KW. which means Max 6KW power can be feed into grid after inverter providing 5Kw to the load firstly. | 0-100% |

Pic 8.26

| Name | Description | Range |
|-----------|--|------------|
| ARC | Arc-fault detection function | ON/OFF/CLR |
| OF-Derate | Active power response to over-frequency | ON/OFF/HYS |
| UF-Uprate | Active power response to under-frequency | ON/OFF |
| PU | power response to grid voltage deviation | ON/OFF |
| LVRT | voltage ride through function | ON/OFF |
| HVRT | voltage ride through function | ON/OFF |
| PowerLim | Hard/soft export limit control | ON/OFF |
| DRM | Demand Response Modes | ON/OFF |
| Sunspec | Sunspec Function | ON/OFF |
| WGraStr | Percentage of Nominal Power per second | 0.1%~10% |
| WGra | percentage of Nominal Power per second | 0.1%~10% |
| ZVRT | Zero Current Mode | ON/OFF |

Pic 8.27

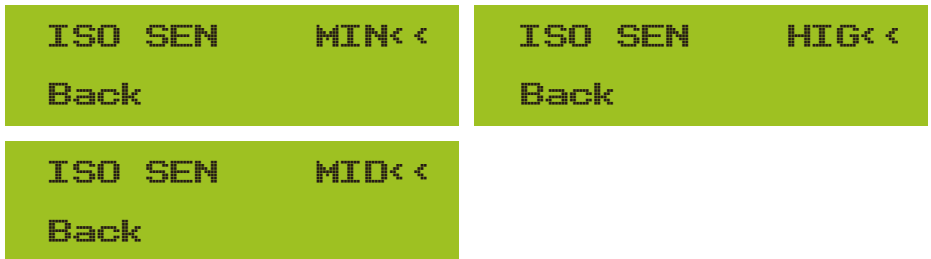

Pic 8.28 FUN_ISO

RCD SEN MIN <<
Back

ARC SEN HIG <<
Back

ARC SEN MID <<
Back

Pic 8.29 FUN_RCD

Island SEN MIN <<
Back

Island SEN HIG <<
Back

Island SEN MID <<
Back

Pic 8.30 Island

ARC SEN HIG <<
Back

ARC SEN MID <<
Back

ARC SEN MIN <<
Back

Pic 8.31 ARC

Over-frequency Response

This series inverter provides “over-frequency response” function. Long pressing the “OFD Mode” to enter the “over-frequency response” setting menu.



Tab. 8-1 Definition of Over-frequency Response Parameters

| Parameter | Range | Description |
|-----------|---------------------|---|
| Fstr | 45HZ-65HZ | The Start frequency value for overfrequency response. |
| Fstop | 45HZ-65HZ | The Stop frequency value for overfrequency response. |
| RecGra | [3,500] 0.01%Pmax/s | Rate of Power recovery(Percentage of active power) |

For example, StrtPT: 50.5Hz, StopPT: 51.5Hz, RecPT: 50.1Hz, when the grid frequency increases beyond Start: 50.5Hz, the inverter will linearly reduce the power output with a gradient of 100% Pmax/Hz until it reaches StopPT: 51.5Hz.

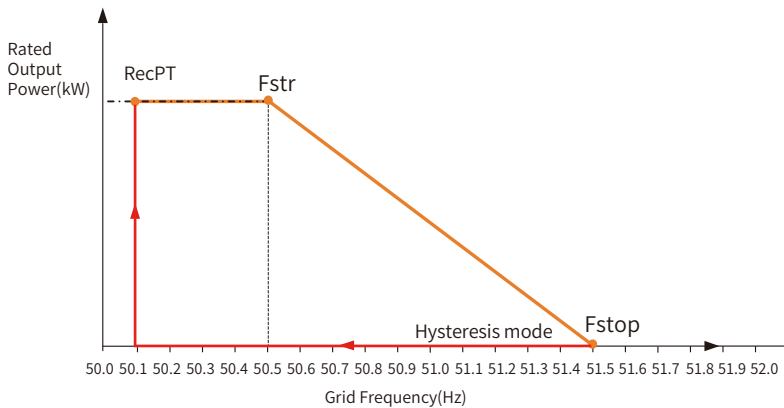
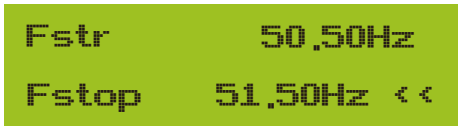

Fig. 8-1 Frq-Watt Mode for Over-frequency Conditions



Pic 8.32 PowerLim



Pic 8.33 LVRT

When the frequency exceeds Fstop: 51.5Hz, the inverter output should stop (ie 0 W).
 When the frequency is lower than Fstop: 51.5 Hz, the inverter will linearly increase the power output with a gradient of 100% Pmax/Hz until it reaches Fstr: 50.5 Hz.
 In the hysteresis mode, when the frequency is lower than Fstop: 51.5 Hz, the inverter will not increase the power output until it is lower than RecPT: 50.1 Hz.



The inverter provides a reactive power regulation function. Tap **Reactive Power Regulation Mode** to select proper regulation mode and set the corresponding parameters.

Pic 8.34 OF-Derate

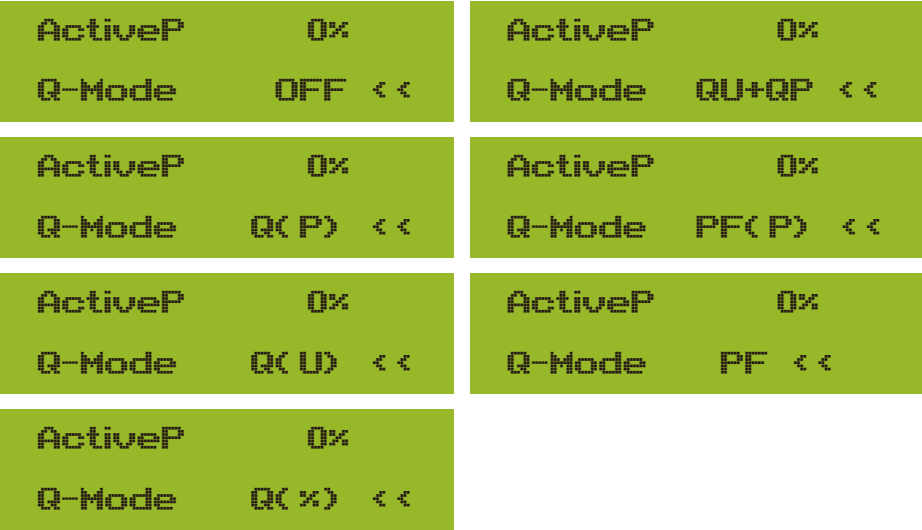

Pic 8.35

- **"OFF" Mode**

The reactive power regulation function is disabled. The PF is fixed at +1.000

- **Q(%)**

Adjust reactive power output in %.

- **"PF" Mode**

The power factor (PF) is fixed and the reactive power is regulated by the parameter PF. The PF ranges from 0.8 leading to 0.8 lagging.

- Leading: the inverter is absorbing reactive power from the Grid.
- Lagging: the inverter is injecting reactive power into the grid.

- **"Q(U)" Mode**

The reactive power output of the inverter varies in response to the grid voltage.

- **"Q(P)" Mode**

The reactive power output by the inverter is controlled by the active power of the inverter.

- **"PF(P)" Mode**

The PF is controlled by the active power of the inverter.

"PU" Mode

The active power output of the inverter varies in response to the grid voltage.

```

UGraStr    0,0%
PU          OFF  <-
  
```

```

UGraStr    0,0%
PU          ON   <-
  
```

```

V1          0,0% <<
P1          0,0%
  
```

```

V2          0,0% <<
P2          0,0%
  
```

```

V3          0,0% <<
P3          0,0%
  
```

```

V4          0,0% <<
P4          0,0%
  
```

```

Ti          0s
OK          Cancel <<
  
```

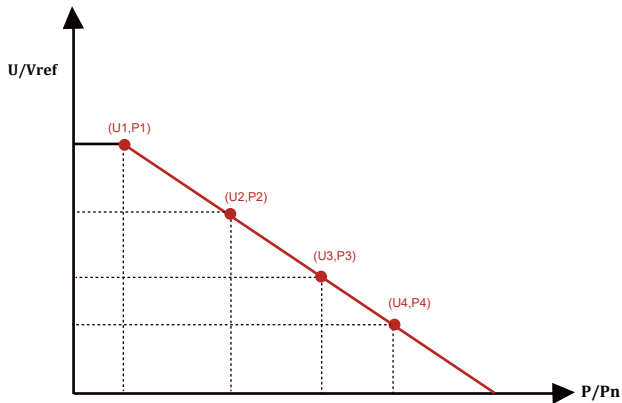

Pic 8.36 Active Power Regulation Curve in PU Curve

| Parameter | Range | Description |
|-----------|---------------|--|
| P1 | 0%-110% Pn | Value of P/Pn at point (P1,U1) on the PU mode curve |
| U1 | 0% -150% Vref | Grid voltage limit at point (P1,U1) on the PU mode curve |
| P2 | 0%-110% Pn | Value of P/Pn at point (P2,U2) on the PU mode curve |
| U2 | 0% -150% Vref | Grid voltage limit at point (P2,U2) on the PU mode curve |
| P3 | 0%-110% Pn | Value of P/Pn at point (P3,U3) on the PU mode curve |
| U3 | 0% -150% Vref | Grid voltage limit at point (P3,U3) on the PU mode curve |
| P4 | 0%-110% Pn | Value of P/Pn at point (P4,U4) on the PU mode curve |
| U4 | 0% -150% Vref | Grid voltage limit at point (P4,U4) on the PU mode curve |
| Ti | 0-1000s | The adjustment time of PU Curve in seconds (time to accomplish a change of 95%). |

"PU" Mode Parameters Explanation

“Q(U)” Mode

| | | | |
|---------|-----------|----------|-----------|
| ActiveP | 0% | Pstart | 0,0% << |
| QMode | Q(U) <- | Pstop | 20,0% |
| RmpTime | 0s | UrefAuto | 0s |
| RmpUref | 0 << | PtUsed | 0 << |
| U1 | 0,0% << | U2 | 0,0% << |
| Q1 | 0,0% | Q2 | 0,0% |
| U3 | 0,0% << | U4 | 0,0% << |
| Q3 | 0,0% | U4 | 0,0% |
| U5 | 0,0% << | U6 | 130,0% << |
| Q5 | 0,0% | Q6 | 30,0% |
| Q6 | 0,0% | | |
| OK | Cancel << | | |

Pic 8.37

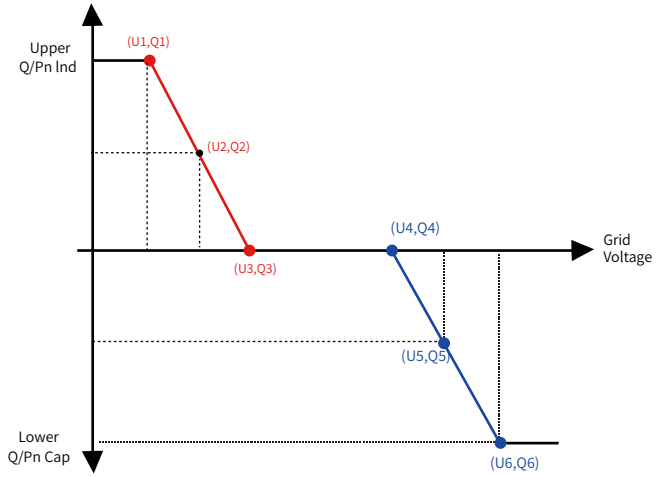

Pic 8.38 Reactive Power Regulation Curve in Q(U) Curve

| Parameter | Range | Description |
|----------------|-------------------------------|--|
| Pstart | 0%-130% Rate out power | The QU mode starts when the active power is greater than this value |
| Pstop | 0%-130% Rate out power | The QU mode stops when the active power is less than this value |
| Q1 | -60% -60% Q/Pn | Value of Q/Pn at point (U1,Q1) on the Q(U) mode curve |
| V1 | 0-110% VRated | Grid voltage limit at point (U1,Q1) on the Q(U) mode curve |
| Q2 | -60% -60% Q/Pn | Value of Q/Pn at point (U2,Q2) on the Q(U) mode curve |
| V2 | 0-110% VRated | Grid voltage limit at point (U2,Q2) on the Q(U) mode curve |
| Q3 | -60% -60% Q/Pn | Value of Q/Pn at point (U3,Q3) on the Q(U) mode curve |
| V3 | 0-110% VRated | Grid voltage limit at point (U3,Q3) on the Q(U) mode curve |
| Q4 | -60% -60% Q/Pn | Value of Q/Pn at point (U4,Q4) on the Q(U) mode curve |
| V4 | 0-110% VRated | Grid voltage limit at point (U4,Q4) on the Q(U) mode curve |
| Q5 | -60% -60% Q/Pn | Value of Q/Pn at point (U5,Q5) on the Q(U) mode curve |
| V5 | 0-110% VRated | Grid voltage limit at point (U5,Q5) on the Q(U) mode curve |
| Q6 | -60% -60% Q/Pn | Value of Q/Pn at point (U6,Q6) on the Q(U) mode curve |
| V6 | 0-110% VRated | Grid voltage limit at point (U6,Q6) on the Q(U) mode curve |
| RmpTime | 0-1000s | Increase or decrease the time required for the reactive power to reach the specified value of the curve. |

"Q(U)" Mode Parameters Explanation

“Q(P)” Mode

The reactive power output by the inverter is controlled by the active power of the inverter.

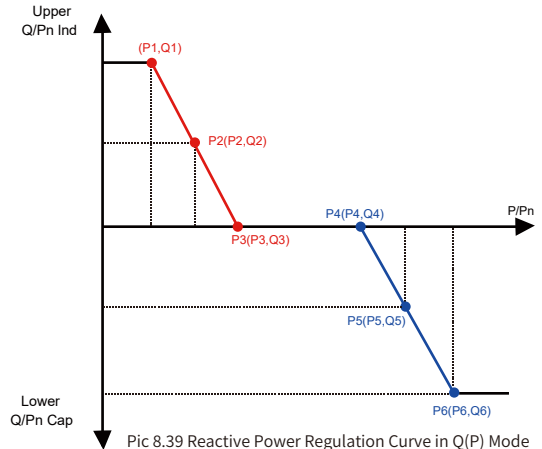

| | | | |
|---------|---------|----|-----------|
| ActiveP | 20,0% | P1 | 0,0% << |
| QMode | QP < - | Q1 | 0,0% |
| P2 | 0,0% << | P3 | 0,0% << |
| Q2 | 0,0% | Q3 | 0,0% |
| P4 | 0,0% << | P5 | 0,0% << |
| Q4 | 0,0% | Q5 | 0,0% |
| P6 | 0,0% << | OK | << Cancel |
| Q6 | 0,0% | | |

| Parameter | Range | Description |
|-----------|----------------------------|--|
| P1 | 0%-100% P _n | Power value/P _n at point (P1,Q1) on the Q(P) mode curve |
| Q1 | -60% -60% Q/P _n | Reactive power value at point (P1,Q1) on the Q(P) mode curve |
| P2 | 0%-100% P _n | Power value/P _n at point (P2,Q2) on the Q(P) mode curve |
| Q2 | -60% -60% Q/P _n | Reactive power value at point (P2,Q2) on the Q(P) mode curve |
| P3 | 0%-100% P _n | Power value/P _n at point (P3,Q3) on the Q(P) mode curve |
| Q3 | -60% -60% Q/P _n | Reactive power value at point (P3,Q3) on the Q(P) mode curve |
| P4 | 0%-100% P _n | Power value/P _n at point (P4,Q4) on the Q(P) mode curve |
| Q4 | -60% -60% Q/P _n | Reactive power value at point (P4,Q4) on the Q(P) mode curve |
| P5 | 0%-100% P _n | Power value/P _n at point (P5,Q5) on the Q(P) mode curve |
| Q5 | -60% -60% Q/P _n | Reactive power value at point (P5,Q5) on the Q(P) mode curve |
| P6 | 0%-100% P _n | Power value/P _n at point (P6,Q6) on the Q(P) mode curve |
| Q6 | -60% -60% Q/P _n | Reactive power value at point (P6,Q6) on the Q(P) mode curve |

"Q(P)" Mode Parameters Explanation

"PF(P)" Mode

The output power factor is controlled by the active power of the inverter.

| | | | |
|--------|-----------|---------|-----------|
| Ustart | 0,0% | P1 | 0,0% |
| Ustop | 0,0% | PF1 | -1,000 << |
| P2 | 0,0% | P3 | 0,0% |
| PF2 | -1,000 << | PF3 | -1,000 << |
| P4 | 0,0% | P5 | 0,0% |
| PF4 | -1,000 << | PF5 | -1,000 << |
| P6 | 0,0% | RmpTime | 0s |
| PF6 | -1,000 << | OK | Cancel << |

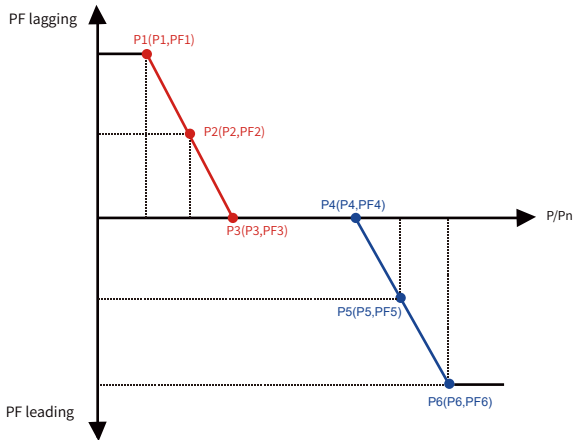

Pic 8.40 Power factor Regulation Curve in PF(P) Mode

| Parameter | Range | Description |
|-----------|---------------------------|--|
| Vstart | 0-150% Vref | The PFP mode is enable when grid voltage is greater than Vstart |
| Vstop | 0-150% Vref | The PFP mode is disable when grid voltage is less than Vstop |
| P1 | 0-110% Pn | Power value at point (PF1,P1) on the PF(P) Curve |
| PF1 | 0.8 leading - 0.8 lagging | PF value at point (PF1,P1) on the PF(P) Curve |
| P2 | 0-110% Pn | Power value at point (PF2,P2) on the PF(P) Curve |
| PF2 | 0.8 leading - 0.8 lagging | PF value at point (P2,PF2) on the PF(P) Curve |
| P3 | 0-110% Pn | Power value at point (P3,PF3) on the PF(P) Curve |
| PF3 | 0.8 leading - 0.8 lagging | PF value at point (P3,PF3) on the PF(P) Curve |
| P4 | 0-110% Pn | Power value at point (P4,PF4) on the PF(P) Curve |
| PF4 | 0.8 leading - 0.8 lagging | PF value at point (P4,PF4) on the PF(P) Curve |
| P5 | 0-110% Pn | Power value at point (P5,PF5) on the PF(P) Curve |
| PF5 | 0.8 leading - 0.8 lagging | PF value at point (P5,PF5) on the PF(P) Curve |
| P6 | 0-110% Pn | Power value at point (P6,PF6) on the PF(P) Curve |
| PF6 | 0.8 leading - 0.8 lagging | PF value at point (P6,PF6) on the PF(P) Curve |
| RmpTime | 0-1000s | The time of the PFF Curve in seconds (time to accomplish a change of 95%). |

"PF(P)" Mode Parameters Explanation

8.5 Protect Param



Warning:

Engineer Only.

We will set the param depends on the safety requirements, so customers don't need to reset it. The password is same as 8.4 Running param



Pic 8.41 Password

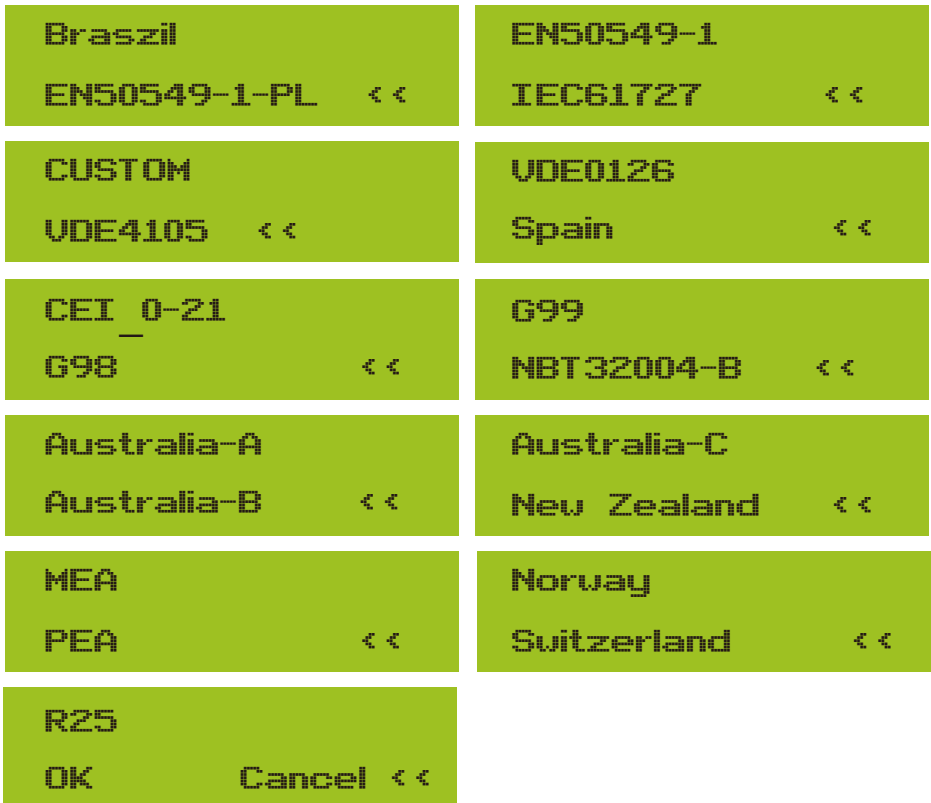

Pic 8.42 GridStandard

OverVolt Lv3
Point 240,0V <<

OverVolt Lv3
Delay 1000ms <<

OverVolt Lv2
Point 240,0V <<

OverVolt Lv2
Delay 1000ms <<

OverVolt Lv1
Point 240,0V <<

OverVolt Lv1
Delay 1000ms <<

UnderVolt Lv1
Point 235,0V <<

UnderVolt Lv1
Delay 1000ms <<

UnderVolt Lv2
Point 235,0V <<

UnderVolt Lv2
Delay 1000ms <<

UnderVolt Lv3
Point 235,0V <<

UnderVolt Lv3
Delay 1000ms <<

OverFreq Lv3
Point 52,00Hz <<

OverFreq Lv3
Delay 1000ms <<

OverFreq Lv2
Point 52,00Hz <<

OverFreq Lv2
Delay 1000ms <<

OverFreq Lv1
Point 52,00Hz <<

OverFreq Lv1
Delay 1000ms <<

UnderFreq Lv1
Point 48,00Hz <<

UnderFreq Lv1
Delay 1000ms <<

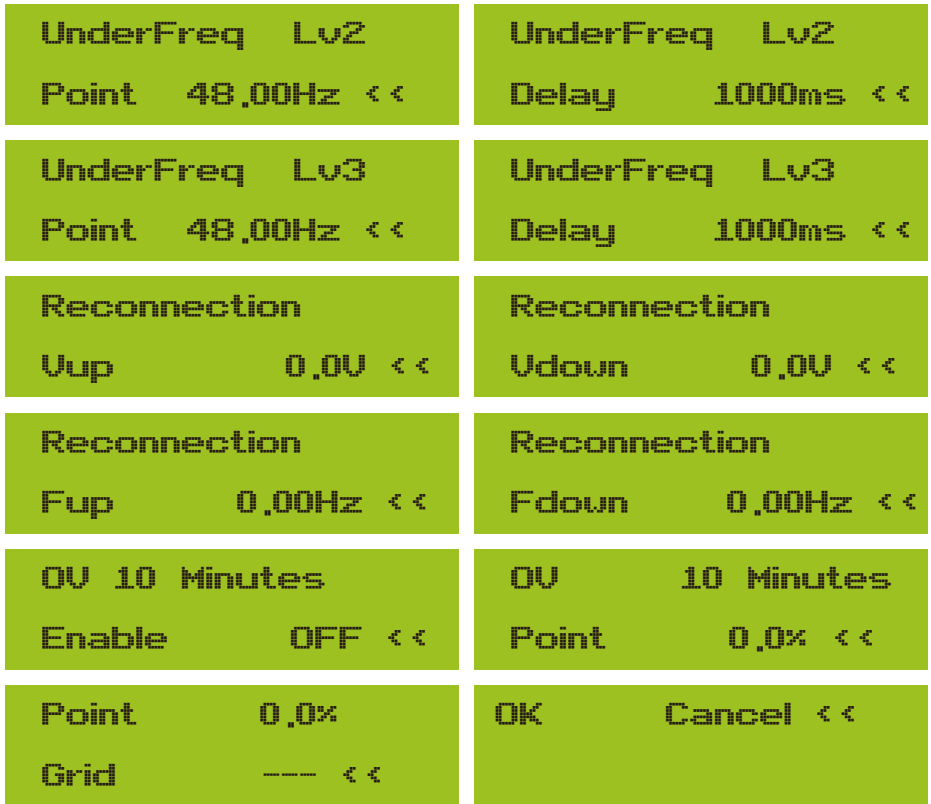

Pic 8.43 “CUSTOMIZED”

Please set the proper grid parameters according to the requirements of your current country's grid regulations. If you are not clear about it, please consult your installer.

8.6 Comm. param set



Pic 8.44 Comm. Param

9. Repair and Maintenance

String type inverter doesn't need regular maintenance. However, debris or dust will affect heat sink's thermal performance. It is better to clean it with a soft brush. If the surface is too dirty and affect the reading of LCD and LED lamp, you can use wet cloth to clean it up.



High Temperature Hazard:

When the device is running, the local temperature is too high and the touch can cause burns. Turn off the inverter and wait for it cooling, then you can clean and maintain.



Safety Hint:

No solvent, abrasive materials or corrosive materials can be used for cleaning any parts of the inverter.

10. Error information and processing

Inverter has been designed in accordance with international grid tied standards for safety, and electromagnetic compatibility requirements. Before delivering to the customer the inverter has been subjected to several tests to ensure its optimal operation and reliability.

10.1 Error code

If there is any failure, the LCD screen will display an alarm message. In this case, the inverter may stop feeding energy into the grid. The alarm description and their corresponding alarm messages are listed in Table 10.1.

| Error code | Description | Ongrid - Three Phase |
|------------|---|--|
| F01 | DC input polarity reverse fault | Check the PV input polarity. |
| F02 | DC insulation impedance permanent fault | Check the grounding cable of inverter. |
| F03 | DC leakage current fault | Hardly appear the code. Never ever happened so far. |
| F04 | Ground fault GFDI | Check the solar panel output connection. |
| F05 | Read the memory error | Failure in reading memory (EEPROM). Restart the inverter if the fault still exists, contact your installer or Deye service. |
| F06 | Write the memory error | Failure in writing memory (EEPROM). Restart the inverter if the fault still exists, contact your installer or Deye service. |
| F07 | GFDI blown fuse | Hardly appear the code. Never ever happened so far. |
| F08 | GFDI grounding touch failure | Hardly appear the code. Never ever happened so far. |
| F09 | IGBT damaged by excessive drop voltage | Hardly appear the code. Never ever happened so far. |
| F10 | Auxiliary switch power supply failure | 1. It tells the DC 12V is not existed. 2. Restart the inverter, if the fault still exists, please contact your installer or Deye service. |
| F11 | AC main contactor errors | Hardly appear the code. Never ever happened so far. |
| F12 | AC auxiliary contactor errors | Hardly appear the code. Never ever happened so far. |
| F13 | reserved | 1. Loss of one phase or AC voltage detection part failure or relays not closed. 2. Restart the inverter, if the error still exists, please contact your installer or Deye service. |
| F14 | DC firmware over current | Hardly appear the code. Never ever happened so far. |
| F15 | AC firmware over current | 1. The internal AC sensor or detection circuit on control board or connection wire may loose. 2. Restart the inverter, if the error still exists, please contact your installer or Deye service. |
| F16 | GFCI(RCD) Ac leakage current fault | 1. This fault means the average leakage current is over 300mA. Check whether DC power supply or solar panels is ok, then check 'Test data' -> 'diL' value is about 40; Then check the leakage current sensor or circuit (the following picture). Checking test data needs using big LCD. 2. Restart the inverter, if the error still exists, please contact your installer or Deye service. |
| F17 | Three phase current, over-current fault | Hardly appear the code. Never ever happened so far. |
| F18 | AC over current fault of hardware | 1. Check AC sensor or detection circuit on control board or connection wire. 2. Restart the inverter or factory reset, if the error still exists, please contact your installer or Deye service. |
| F19 | All hardware failure synthesis | Hardly appear the code. Never ever happened so far. |

| Error code | Description | Ongrid - Three Phase |
|------------|--|--|
| F20 | DC over current fault of the hardware | <ol style="list-style-type: none"> 1. Check whether solar panel output current is within the allowed range. 2. Check DC current sensor and its detection circuit. 3. Check if the inverter FW version is suitable for the hardware. 4. Restart the inverter, if the error still exists, please contact your installer or Deye service. |
| F21 | DC leakage flow fault | Hardly appear the code. Never ever happened so far. |
| F22 | Crash stop (if there is a stop button) | Contact your installer for help. |
| F23 | AC leakage current is transient over current | <ol style="list-style-type: none"> 1. This fault means the leakage current is above 30mA suddenly. Check whether DC power supply or solar panels is ok, then check 'Test data'-> 'dil' value is about 40; Then check the leakage current sensor or circuit. Check test data needs using big LCD. 2. Restart the inverter, if the fault still exists, contact your installer or Deye service. |
| F24 | DC insulation impedance failure | <ol style="list-style-type: none"> 1. Check Vpe resistance on main board or detection on control board. Check PV panels is OK. Many times this issue is the PV problem. 2. Check whether the PV panel (aluminum frame) is grounded well and inverter is grounded well. Open the cover of inverter and then check the inside ground cable is fixed well on the shell. 3. Check if the AC/DC cable, terminal block are shorted to ground or the insulation is damaged. 4. Restart the inverter, if the fault still exists, contact your installer or Deye service. |
| F25 | DC feedback fault | Hardly appear the code. Never ever happened so far. |
| F26 | The DC busbar is unbalanced | <ol style="list-style-type: none"> 1. Check whether the 'BUSN' cable or driver board power supply cable is loose. 2. Restart the inverter, if the fault still exists, contact your installer or Deye service. |
| F27 | DC end insulation error | Hardly appear the code. Never ever happened so far. |
| F28 | Inverter 1 DC high fault | Hardly appear the code. Never ever happened so far. |
| F29 | AC load switch failure | Hardly appear the code. Never ever happened so far. |
| F30 | AC main contactor failure | <ol style="list-style-type: none"> 1. Check relays and AC voltage of relays. 2. Check relays driver circuit. Check if the software is not suitable for this inverter. (Old inverter not have relays detection function) 3. Restart the inverter, if the fault still exists, contact your installer or Deye service. |
| F31 | Relay open circuit fault | <ol style="list-style-type: none"> 1. At least one Relay can't be closed. Check relays and its driver signal. (Old inverter not have relays detection function) 2. Restart the inverter, if the fault still exists, contact your installer or Deye service. |
| F32 | Inverter 2 dc high fault | Hardly appear the code. Never ever happened so far. |
| F33 | AC over current | Hardly appear the code. Never ever happened so far. |
| F34 | AC current over load | Hardly appear the code. Never ever happened so far. |
| F35 | No AC grid | <ol style="list-style-type: none"> 1. Check AC grid voltage. Check AC voltage detection circuit. Check if the AC connector in good condition. Check whether the AC grid is normal in voltage. 2. Restart the inverter, if the fault still exists, contact your installer or Deye service. |

| Error code | Description | Ongrid - Three Phase |
|------------|--|--|
| F36 | AC grid phase error | Hardly appear the code. Never ever happened so far. |
| F37 | AC three-phase voltage unbalance failure | Hardly appear the code. Never ever happened so far. |
| F38 | AC three-phase current unbalance failure | Hardly appear the code. Never ever happened so far. |
| F39 | AC over current(one cycle) | 1. Check AC current sensor and its circuit. 2. Restart the inverter, if the fault still exists, contact your installer or Deye service. |
| F40 | DC over current | Hardly appear the code. Never ever happened so far. |
| F41 | AC Line W,U over voltage | Check the AC voltage protection setting. And Check if the AC cable is too thin.Check the voltage difference between LCD and meter. |
| F42 | AC Line W,U low voltage | Check the AC voltage protection setting. Check the voltage difference between LCD and meter. Also need to check whether AC cables are all firmly and correctly connected. |
| F43 | AC Line V,W over voltage | Check the AC voltage protection setting.And Check if the AC cable is too thin.Check the voltage difference between LCD and meter. |
| F44 | AC Line V,W low voltage | Check the AC voltage protection setting. Check the voltage difference between LCD and meter. Also need to check whether AC cables are all firmly and correctly connected. |
| F45 | AC Line U,V over voltage | Check the AC voltage protection setting.And Check if the AC cable is too thin.Check the voltage difference between LCD and meter. |
| F46 | AC Line U,V low voltage | Check the AC voltage protection setting. |
| F47 | AC Over frequency | Check the frequency protection setting. |
| F48 | AC lower frequency | Check the frequency protection setting. |
| F49 | U phase grid current DC component over current | Hardly appear the code. Never ever happened so far. |
| F50 | V phase grid current DC component over current | Hardly appear the code. Never ever happened so far. |
| F51 | W phase grid current DC component over current | Hardly appear the code. Never ever happened so far. |
| F52 | AC inductor A, phase current DC current high | Hardly appear the code. Never ever happened so far. |
| F53 | AC inductor B, phase current DC current high | Hardly appear the code. Never ever happened so far. |
| F54 | AC inductor C, phase current DC current high | Hardly appear the code. Never ever happened so far. |
| F55 | DC busbar voltage is too high | 1. Check PV voltage and Ubus voltage and its detection circuit. If the PV input voltage exceeds the limit, please reduce the number of solar panels in series. 2. For Ubus voltage, please check the LCD display. |

| Error code | Description | Ongrid - Three Phase |
|------------|---------------------------------|---|
| F56 | DC busbar voltage is too low | <ol style="list-style-type: none"> 1. It tells the PV input voltage is low and it always happens in the early morning. 2. Check PV voltage and Ubus voltage. When inverter is running, then showing F56, maybe Loss of driver or need update firmware. 3. Restart the inverter, if the fault still exists, contact your installer or Deye service. |
| F57 | AC reverse irrigation | AC reverse irrigation. |
| F58 | AC grid U over current | Hardly appear the code. Never ever happened so far. |
| F59 | AC grid V over current | Hardly appear the code. Never ever happened so far. |
| F60 | AC grid W over current | Hardly appear the code. Never ever happened so far. |
| F61 | Reactor A phase over current | Hardly appear the code. Never ever happened so far. |
| F62 | Reactor B phase over current | Hardly appear the code. Never ever happened so far. |
| F63 | ARC fault | <ol style="list-style-type: none"> 1. Check PV module cable connection and clear the fault; 2. Seek help from us, if can not go back to normal state. |
| F64 | IGBT heat sink high temperature | <ol style="list-style-type: none"> 1. Check temperature sensor. Check if firmware is suitable for the hardware. Check if the inverter is its right model. 2. Restart the inverter, if the fault still exists, contact your installer or Deye service. |

Table10.1 Error codes and their solutions



Safety Hint:

If your string inverter has any of the fault information shown in Table 10-1, and when you reset the machine and still don't solve the problem, please contact our distributor and provide the below details:

1. Serial number of the inverter;
2. The distributor/dealer of the inverter(if available);
3. Installation date;
4. The discription of problem(include LCD'error code and LED starus indicator lights);
5. Your contact details.

11.Specification

| Model | SUN-3K-G05-1-P | SUN-3K-G05-P | SUN-4K-G05-P | SUN-5K-G05-P | SUN-6K-G05-P |
|--|---|--------------|--------------|--------------|--------------|
| Input Side | | | | | |
| Max.DC Power(kW) | 3.9kW | 3.9kW | 5.2kW | 6.5kW | 7.8kW |
| Max.DC Input Voltage(V) | 1000V | | | | |
| Start-up DC Input Voltage(V) | 140V | | | | |
| MPPT Operating Range(V) | 120V~850V | | | | |
| Rated DC input voltage(V) | 600V | | | | |
| MPPT Full Power Voltage Range(V) | 350V~850V | | | | |
| Max.DC Input Current(A) | 20A | 20A+20A | | | |
| Max. Short Circuit Current (A) | 30A | 30A+30A | | | |
| Number of MPPT/Strings per MPPT | 1/1 | 2/1+1 | | | |
| MAX inverter backfeed current (A) | 0A | | | | |
| Output Side | | | | | |
| Rated Output Power(kW) | 3kW | 3kW | 4kW | 5kW | 6kW |
| Max.Active Power(kW) | 3.3kW | 3.3kW | 4.4kW | 5.5kW | 6.6kW |
| Rated AC Grid Voltage(V) | 3L/N/PE 220/380V 230/400V | | | | |
| AC Grid Voltage Range(V) | 0.85Un-1.1Un (this may vary with grid standards) | | | | |
| Rated Grid Frequency(Hz) | 50/60 (Optional) | | | | |
| Operating Phase | Three phase | | | | |
| Rated AC Grid Output Current(A) | 4.5/4.3A | 4.5/4.3A | 6.1/5.8A | 7.6/7.2A | 9.1/8.7A |
| Max.AC Output Current(A) | 5/4.8A | 5/4.8A | 6.7/6.4A | 8.3/8A | 10/9.6A |
| Maximum output fault current (a.c. A, peak) | 8.2A | 8.2A | 11.1A | 13.7A | 16.6A |
| Maximum output overcurrent protection (a.c. A, peak) | 9.12A | 9.12A | 12.3A | 15.3A | 18.5A |
| Output Power Factor | 0.8 leading~0.8 lagging | | | | |
| Grid Current THD | <3% | | | | |
| DC Injection Current(mA) | <0.5% | | | | |
| Grid Frequency Range | 45-55 or 55-65 (Optional) | | | | |
| Efficiency | | | | | |
| Max.Efficiency | 98.1% | | | 98.2% | |
| Euro Efficiency | 97.5% | | | | |
| MPPT Efficiency | >99% | | | | |
| Surge Protection | DC Type II / AC Type II | | | | |
| General Data | | | | | |
| Cabinet Size(W*H*D) [mm] | 332×457×203 (Excluding connectors and brackets) | | | | |
| Weight(kg) | 11 | | | | |
| Topology | Transformerless | | | | |
| Internal consumption | <1W (Night) | | | | |
| Operating temperature | -25 ~ 65°C,>45°C derating | | | | |
| Ingress protection | IP65 | | | | |
| Noise Emission(Typical) | ≤ 30dB | | | | |
| Type Of Cooling | Free cooling | | | | |
| Permissible Altitude (m) | 4000m | | | | |
| Warranty [year] | Standard 5 years, extended warranty | | | | |
| Grid Connection Standard | IEC 61727, IEC 62116, CEI 0-21, EN 50549, NRS 097, RD 140, UNE 217002, OVE-Richtlinie R25, G99, VDE-AR-N 4105 | | | | |
| Operation surrounding humidity | 0~100% | | | | |
| Safety EMC / Standard | IEC/EN 61000-6-1/2/3/4, IEC/EN 62109-1, IEC/EN 62109-2 | | | | |

General Data

| | |
|-----------|----------------------|
| Display | LCD1602 |
| Interface | RS485/RS232/Wifi/LAN |

| Model | SUN-7K-G05-P | SUN-8K-G05-P | SUN-9K-G05-P | SUN-10K-G05-P | SUN-12K-G05-P |
|--|---|--------------|--------------|---------------|---------------|
| Input Side | | | | | |
| Max.DC Power(kW) | 9.1kW | 10.4kW | 11.7kW | 13kW | 15.6kW |
| Max.DC Input Voltage(V) | 1000V | | | | |
| Start-up DC Input Voltage(V) | 140V | | | | 250V |
| MPPT Operating Range(V) | 120V~850V | | | | 200V~850V |
| Rated DC input voltage(V) | 600V | | | | |
| MPPT Full Power Voltage Range(V) | 480V~850V | | | | |
| Max.DC Input Current(A) | 20A+20A | | | | |
| Max. Short Circuit Current (A) | 30A+30A | | | | |
| Number of MPPT/Strings per MPPT | 2/1+1 | | | | |
| MAX inverter backfeed current (A) | 0 | | | | |
| Output Side | | | | | |
| Rated Output Power(kW) | 7kW | 8kW | 9kW | 10kW | 12kW |
| Max.Active Power(kW) | 7.7kW | 8.8kW | 9.9kW | 11kW | 13.2kW |
| Rated AC Grid Voltage(V) | 3L/N/PE 220/380V 230/400V | | | | |
| AC Grid Voltage Range(V) | 0.85Un-1.1Un (this may vary with grid standards) | | | | |
| Rated Grid Frequency(Hz) | 50/60 (Optional) | | | | |
| Operating Phase | Three phase | | | | |
| Rated AC Grid Output Current(A) | 10.6/10.1A | 12.1/11.6A | 13.6/13.0A | 15.2/14.5A | 18.2/17.4A |
| Max.AC Output Current(A) | 11.7/11.1A | 13.3/12.8A | 15/14.3A | 16.7/15.9A | 20/19.1A |
| Maximum output fault current (a.c. A, peak) | 19.3A | 22.1A | 24.8A | 27.7A | 33.2A |
| Maximum output overcurrent protection (a.c. A, peak) | 21.4A | 24.6A | 27.6A | 30.8A | 36.9A |
| Output Power Factor | 0.8 leading~0.8 lagging | | | | |
| Grid Current THD | <3% | | | | |
| DC Injection Current(mA) | <0.5% | | | | |
| Grid Frequency Range | 45-55 or 55-65 (Optional) | | | | |
| Efficiency | | | | | |
| Max.Efficiency | 98.3% | | | | |
| Euro Efficiency | 97.5% | | | | |
| MPPT Efficiency | >99% | | | | |
| Surge Protection | DC Type II / AC Type II | | | | |
| General Data | | | | | |
| Cabinet Size(W*H*D) [mm] | 332×457×203 (Excluding connectors and brackets) | | | | |
| Weight(kg) | 11 | | | | |
| Topology | Transformerless | | | | |
| Internal consumption | <1W (Night) | | | | |
| Operating temperature | -25 ~ 65°C,>45°C derating | | | | |
| Ingress protection | IP65 | | | | |
| Noise Emission(Typical) | ≤ 30dB | | | | |
| Type Of Cooling | Free cooling | | | | |
| Permissible Altitude (m) | 4000m | | | | |
| Warranty [year] | Standard 5 years, extended warranty | | | | |
| Grid Connection Standard | IEC 61727, IEC 62116, CEI 0-21, EN 50549, NRS 097, RD 140, UNE 217002, OVE-Richtlinie R25, G99, VDE-AR-N 4105 | | | | |
| Operation surrounding humidity | 0~100% | | | | |
| Safety EMC / Standard | IEC/EN 61000-6-1/2/3/4, IEC/EN 62109-1, IEC/EN 62109-2 | | | | |

General Data

| | |
|-----------|----------------------|
| Display | LCD1602 |
| Interface | RS485/RS232/Wifi/LAN |

2023-06-16 Ver: 2.4

NINGBO DEYE INVERTER TECHNOLOGY CO., LTD.

Add: No.26 South YongJiang Road, Daqi, Beilun, NingBo, China.

Tel: +86 (0) 574 8622 8957

Fax: +86 (0) 574 8622 8852

E-mail: service@deye.com.cn

Web: www.deyeinverter.com



30240301001877